

**OFF-
ROAD
LIVIN'**

can-am®

**2021 ACCESSORIES
APAC EDITION**

**OUTLANDER
RENEGADE**

**IT'S ALL HERE,
NOW GET
OUT THERE.**

**FIT &
COMPATIBILITY**



FOR US, INNOVATION IS A NO BRAINER.
ALL OUR ACCESSORIES WORK TOGETHER,
RIGHT OUT OF THE BOX. SO TAKE YOUR
PICK. THEN PICK SOME MORE.

can-am

STYLE & VISION



WE'VE UPPED THE ANTE ON ACCESSORIES. NOT JUST DESIGNED TO LOOK GOOD, BUT PERFORM RIGHT FOR REAL RIDERS. ALL KILLER, NO FILLER.

QUALITY & RELIABILITY



OUR CAN-AM ACCESSORIES ARE MADE RIGHT THE FIRST TIME. AND TO TOP IT OFF WE THREW IN A 1-YEAR WARRANTY. YOU'RE WELCOME. INSTALL THEM YOURSELF OR AT AN AUTHORIZED DEALER.

**BRP 1-YEAR
LIMITED WARRANTY**

For new Can-Am accessories, genuine parts, and co-branded products sold through BRP. Includes items installed by you or an authorized BRP dealer.

2021



**EXPERT
CHOICE**

LOOK FOR THIS LOGO THROUGHOUT THE CATALOGUE FOR EXPERT RECOMMENDATIONS ON INNOVATIVE, MUST-HAVE, ENTHUSIAST-READY PARTS AND ACCESSORIES THAT WILL HELP YOU CUSTOMIZE YOUR PERFECT OFF-ROAD MACHINE.



can-am®

OUTLANDER RENEGADE

ACCESSORIES

Built Inspirations	6
Build your own	12
Compatibility Guide	13
LinQ: Easy On, Easy Off Cargo	14
Cargo & Storage	21
Windshields	23
Seats	27
Racks & Holders	28
Skid Plates	30
Bumpers & Guards	34
Lights & Electrical	38
Winches	42
Hitches	44
Performance	45
Covers, Decals & Add-ons	49
Apache™ Track Systems	50
Promount Plows	55
Tires & Rims	61

CAN-AMOFFROAD.COM

© 2020 Bombardier Recreational Products Inc. (BRP). All rights reserved. ®, TM and the BRP logo are trademarks of BRP or its affiliates. CARLISLE is a trademark of Carlisle Companies. CHAMUDE and HIPORA are registered trademarks of Kolon Industries, Inc. CLARINO is a trademark of Kuraray Co. Ltd. COOLMAX and THERMOLITE are registered trademarks of INVISTA for durable fabrics. DRIRELEASE is a registered trademark of Optimer Inc. FOX is a registered trademark of Fox Racing Canada. GARMIN and MONTANA are registered trademarks of Garmin Ltd. iPod is a registered trademark of Apple Inc. KOLPIN, GUN BOOT and IMPACT are registered trademarks of Kolpin Powersports Inc. KYB is a registered trademark of Kayaba. MicroSD is a registered trademark of SD Card Association. Mud Lite XTR and SS312 are trademarks of ITP Tires. NEXT G-1 VISTA is a trademark of Next Camo, LLC. NGK is a registered trademark of NGK Spark Plugs, Ltd. PRIMALOFT GOLD and PRIMALOFT BLACK are registered trademarks of Albany International Corp. TEFLON, TEFLON HT and KEVLAR are trademarks of E.I. DuPont de Nemours & Co. TWINAIR is a trademark of Twin Air USA. UNI is a trademark of UNIFILTER Inc. VELCRO is a registered trademark of Velcro Industries. WARN is a trademark of Warn Industries Inc. YUASA is a registered trademark of YUASA Batteries Inc. ZILLA and BIGHORN 2.0 are trademarks of Maxxis. SCOTT is a trademark of Scott Sports SA. The following trademarks are the property of their respective owners: BLUETOOTH, CREE, DURO, DWT, HELLA, ITP, KENDA, MOSSY OAK, RAM, SUR LAST, VISION, XPS and YOSHIMURA. DRAGONFIRE is a trademark of KRANSCO. Baja Designs is a registered trademark of Baja Designs Inc. S3 POWERSPORTS is a trademark of S3 Power Sports LLC. Some models depicted herein may include optional equipment. Prices, if shown, are based on Manufacturer Suggested Retail Prices. Dealers may sell for a different price. For Canada and US, taxes are not included. Depending on location, products are distributed by BRP US Inc., Bombardier Recreational Products Inc., BRP European Distribution SA, BRP Finland Oy., BRP Australia Pty Ltd. or BRP Brasil Motorsports LTDA. BRP reserves the right, at any time, to discontinue or change specifications, prices, designs, features, equipment without incurring obligation. Printed in Canada.

EXPERTLY-CHOSEN PACKAGES

ADD THE ACCESSORIES YOU WANT WITH 3 LEVELS OF UPGRADES: **STARTER**, **ADVANCED**, AND **PEAK**. OR MIX AND MATCH OPTIONS—IT'S YOUR RIDE.

STARTER

Essential, recommended upgrades to immediately enhance any Can-Am vehicle.

ADVANCED

The best all-round, do-anything upgrades that have proven popular with experienced riders and new owners alike. Transform your Can-Am for the years of riding ahead.

PEAK

Limits are for other people: build your Can-Am Off-Road vehicle to overcome bigger obstacles & ride through larger adventures.

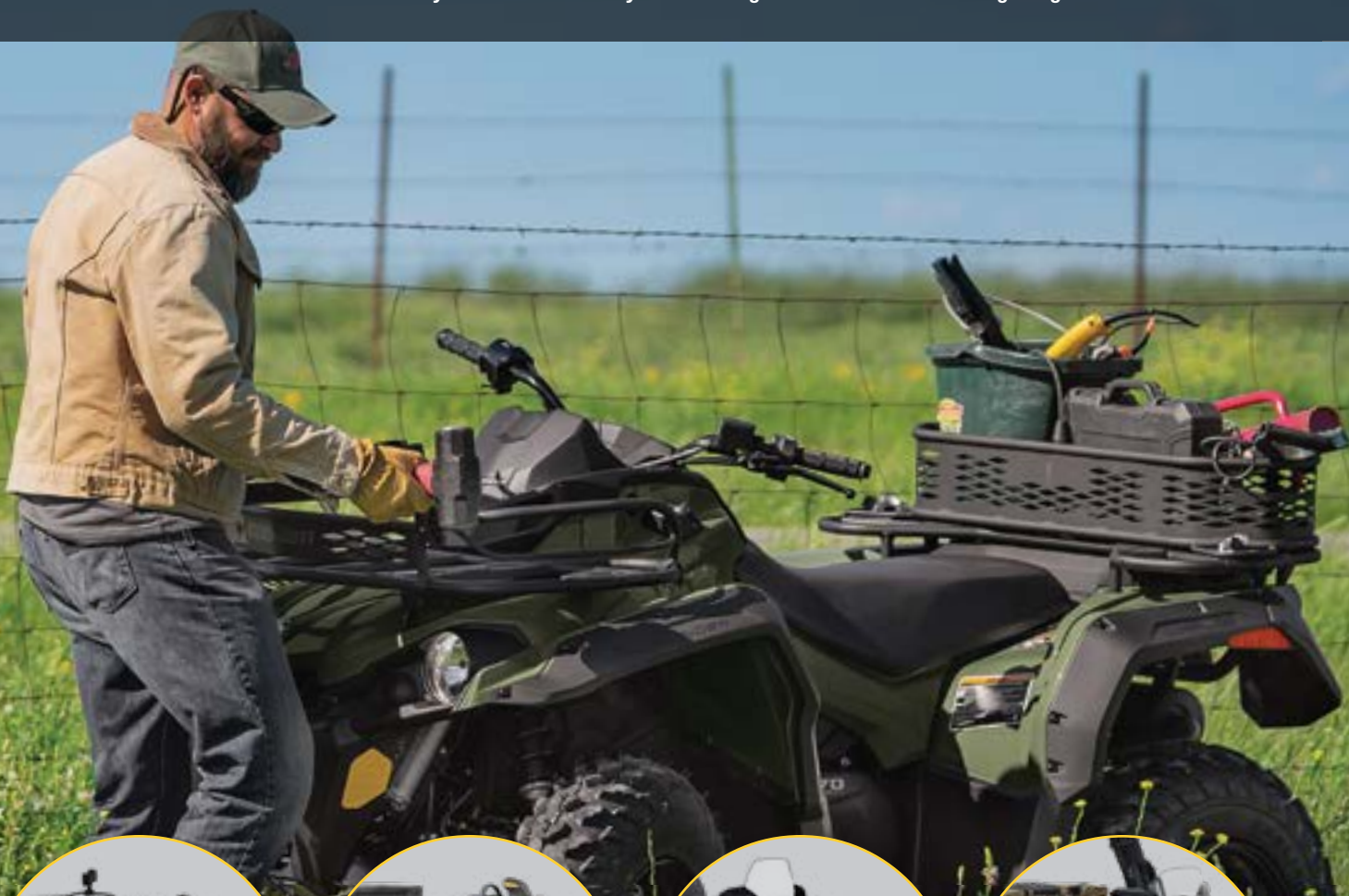

HARD WORK



MUD



WINTER



HUNTING

YOU CAN FINANCE THE PURCHASE OF ACCESSORIES

with the purchase and financing of your Outlander or Renegade. Ask your dealer for all the details.

TAKE ON THE TOUGH TASKS WITH UTILITY UPGRADES THAT WORK SEAMLESSLY AND TIRELESSLY WITH YOU & YOUR OUTLANDER.



OUTLANDER

HARD WORK

STARTER

715001215	LinQ Heavy-Duty Basket	p. 19
715001914	8" (20 cm) Rack Extension	p. 28
715006108	Warn VRX 35 Winch	p. 42

ADVANCED

715001909	Fender Flares	p. 37
715003461	Rancher Front Bumper	p. 36
715003462	Rancher Rear Bumper	p. 36
715003459	Body Side Protector	p. 35

PEAK

715001945	Multi-Fit Holder	p. 29
710005423	Ram LED Spotlight	p. 40
715005186	Rear Hitch Receiver	p. 44
715000972	Front & Rear Hitch Drawbar	p. 44

*Note that price does not include installation requirements and that part numbers may vary depending on vehicle model.

ADAPT QUICKLY FOR
THE HUNT BY OUTFITTING
THE OUTLANDER TO
YOUR EXACT NEEDS





OUTLANDER
 For the international market,
 the Squadron Green color is only
 available on the Outlander 570 PRO.

HUNTING

STARTER

715003248	LinQ Premium Storage Bag by Ogio	p. 19
715003021	Low Windshield kit	p. 25
715001419	Gun Boot 6.0 Impact by Kolpin	p. 29
715001918	Gun Boot Rack	p. 29

ADVANCED

715004282	LinQ Low Profile Basket	p. 19
715001910	XT Front Bumper	p. 35
715001911	XT Rear Bumper	p. 35
715003614	Body Side Protector	p. 35
715004279	Extreme Front Bumper	p. 37
715001909	Fender Flares	p. 37

PEAK

715004199	Aluminum Skid Plate	p. 31
715003250	Heated Grips & Thumb Throttle Combo	p. 38
710005423	RAM LED Spotlight	p. 40
715006415	Can-Am HD 3500 winch	p. 42

*Note that price does not include installation requirements and that part numbers may vary depending on vehicle model. For G1 accessories, refer to your local dealer.

GO FARTHER WITH
PROVEN TRAIL
ACCESSORIES FOR
ALL-DAY COMFORT
& RELIABILITY



OUTLANDER

MUD

STARTER

715003053	Mud Strap	p. 45
715000550	Aluminum Tapered Handlebar	p. 26
715004729	Air Intake Pre-Filter	p. 54
715001379	Short Aluminum Mounting Kit	p. 26
715000525	Handlebar Wind Deflector	p. 26
715002518	Snorkel Kit	p. 46

ADVANCED

715004778	LinQ 8 Gal (30 L) Cooler Box	p. 19
715005480	Yoshimura Slip-on Exhaust	p. 47

PEAK

715004759	Self-Clearing Footwells	p. 46
21900840	Bluetooth Handlebar Soundbar by MTX	p. 39
715004284	Baja Designs High Beam Kit	p. 40

*Note that price does not include installation requirements and that part numbers may vary depending on vehicle model.

FINALLY ENJOY WINTER WITH COLD-WEATHER ESSENTIALS: THE CAN-AM APACHE TRACK SYSTEM & PROMOUNT PLOW KIT



OUTLANDER MAX

WINTER

STARTER

715004282	LinQ Low Profile Basket	p. 19
715003023	Extra-High Windshield Kit	p. 25
715004815	Heated Grips & Thumb Throttle Combo	p. 38
715001246	Heated Visor Outlet	p. 38

ADVANCED

715001926	Heated Passenger Grips & Visor Outlet	p. 38
715004301	LinQ Tool Box	p. 16
715005111	Fender Flare Extensions	p. 37
715004293	2" (5 cm) Square LED Lights	p. 40

TRACKS

715005103	Apache 360 LT Track System	p. 52
715007206	Apache 360 LT Mounting Kit	p. 54

PLOW

715006109	Warn VRX 35-S Winch	p. 42
715005202	Can-Am ProMount Flex2 60" (152 cm) Kit	p. 58
715006257	Can-Am ProMount Push Frame Extension	p. 59
715004207	Can-Am Promount Drift Cutters	p. 60
715004206	Can-Am Promount Edge Markers	p. 60

*Note that price does not include installation requirements and that part numbers may vary depending on vehicle model.

YOU'VE SEEN THE OPTIONS... NOW
BUILD YOUR OWN



Create the ride you always dreamed of using our outstanding range of quality accessories.

Customize your own Can-Am Off-Road at
CAN-AM.BRP.COM/OFF-ROAD

ATV ACCESSORY COMPATIBILITY GUIDE

We've made things super simple.

- Check your model year
- Choose engine and model
- Learn your **PLATFORM CODE**

This **PLATFORM CODE** will let you know at a glance if the accessory is compatible with your vehicle.

EXAMPLE

CARGO BAG

- Rugged all-purpose cargo bag with rain cover for additional protection against the elements.
- LinQ Luggage Rack (715001734) is required for G2S.

G2, G2L, G2S
295100698

MODEL YEAR	MODEL	ENGINE CONFIGURATION	PLATFORM CODE
2013	Outlander	400	G1
	Outlander	500, 650, 800, 1000	G2
	Outlander MAX	400	G1
	Outlander MAX	500, 650, 800	G2
	Renegade	500, 800, 1000	G2S
2014	Outlander	400	G1
	Outlander	500, 650, 800, 1000	G2
	Outlander MAX	400	G1
	Outlander MAX	500, 650, 800, 1000	G2
	Renegade	500, 800, 1000	G2S
2015	Outlander L	450, 500	G2L
	Outlander	500, 650, 800, 1000	G2
	Outlander L MAX	450, 500	G2L
	Outlander MAX	500, 650, 800, 1000	G2
	6x6	650, 1000	G2
	Renegade	500, 800, 1000	G2S
2016	Outlander L	450, 570	G2L
	Outlander	570, 650, 850, 1000	G2
	Outlander L MAX	450, 570	G2L
	Outlander MAX	570, 650, 850, 1000	G2
	6x6	650, 1000	G2
	Renegade	570, 850, 1000	G2S
2017 2018	Outlander	450, 570	G2L
	Outlander	650, 850, 1000	G2
	Outlander MAX	450, 570	G2L
	Outlander MAX	650, 850, 1000	G2
	6x6	650, 1000	G2
	Renegade	570, 850, 1000	G2S
2019 2020 2021	Outlander	450, 570	G2L
	Outlander	650, 850, 1000R	G2
	Outlander MAX	450, 570	G2L
	Outlander MAX	650, 850, 1000R	G2
	6x6	450	G2L
	6x6	650, 1000	G2
	Renegade	570, 650, 850, 1000R	G2



G2L 6x6



G2 6x6



G2



G2L



G2S



G1

EASY ON, EASY OFF CARGO



A BRP EXCLUSIVE, LinQ IS A TOOL-LESS SYSTEM FOR NEAR-INSTANT INSTALLATION OF ACCESSORIES. QUICKLY, EASILY INSTALL AND REMOVE LinQ ACCESSORIES TO TRANSFORM YOUR MACHINE TO FIT THE MOMENT.



YOUR ADVENTURE, OUTFITTED

LinQ trunk boxes, rack extensions, bags, baskets, and gear grips attach quickly for your next expedition.



TOOL-LESS

Twist LinQ fasteners and go!

LinQ ACCESSORY TYPES





- LinQ with 16" base accessories are mounted with LinQ anchors 16 inches apart, ideal for Can-Am ATVs and SSVs, Sea-Doo watercraft, and Ski-Doo snowmobiles.
- LinQ with 36" base accessories are most commonly used as part of LinQ racks for Can-Am Off-Road vehicles.



LinQ SYSTEM™ ACCESSORIES

- No tools needed: Quickly install and remove accessories by hand
- Equip your Can-Am for specialized tasks in no time
- Sturdy mounting system that holds up to the roughest terrain









LinQ ACCESSORIES WITH 16" BASE p. 16

	LinQ 4.2 GAL (16 L) COOLER 219400964 • Black / 295100698 • White
	LinQ TOOL BOX 715004301
	LinQ SR 5.5 GAL (21 L) BAG 860201740
	LinQ 4.5 GAL (17 L) SPORT BAG 860201678
	LinQ DRY BAG 715002875

COMPATIBILITY/REQUIREMENTS		
OUTLANDER 450/570	OUTLANDER	RENEGADE
<ul style="list-style-type: none"> • LinQ anchors mounted 16 inches apart, center-to-center. • Lower loading capacity than the LinQ with 36" base accessories. • Can be used on Can-Am ATV and SSV vehicles, Sea-Doo watercraft and Ski-Doo snowmobiles. 		

Not compatible	LinQ Anchor Adaptor Kit 715004960	LinQ Luggage Rack 715001734 + LinQ Anchor Adaptor Kit 715004960
----------------	--------------------------------------	---





LinQ ACCESSORIES WITH 36" BASE p. 17

	LinQ 12 GAL (45 L) CARGO BOX 715003879
	LinQ 23 GAL (86 L) TRUNK BOX 715004923
	LinQ 32 GAL (121 L) TRUNK BOX 715001747 / 715001749 (MAX)
	LinQ 11.5 GAL (43 L) AUDIO CARGO BOX 715003018
	LinQ 8 GAL (30 L) COOLER BOX 715004778 • Black / 715004698 • Grey
	LinQ PREMIUM STORAGE BAG BY OGIO 715002923 • Black / 715003248 • Camo
	LinQ HEAVY-DUTY BASKET 715001215
	LinQ LOW PROFILE BASKET 715004282

- Mount on LinQ racks often used by Can-Am ORV vehicles.
- Higher loading capacity than the LinQ with 16" base accessories.
- Usage is limited to Can-Am ORV vehicles.

LinQ Base 715002350	No further requirements	LinQ Luggage Rack 715001734
Not compatible		
LinQ Base 715002350	No further requirements	LinQ Luggage Rack 715001734
Not compatible		
LinQ Base 715002350	No further requirements	LinQ Luggage Rack 715001734
Not compatible		

LinQ RACKS & HOLDERS

	LinQ 4" RACK 715001711 • Silver / 715001665 • Black
	LinQ 6" (15 CM) RACK EXTENSION 715001712 • Silver / 715001671 • Black
	LinQ MOUNTED GEAR GRIPS 715001351
	LinQ TOOL HOLDER 715003059
	LinQ GUN BOOT RACK 715002112 / 715002113

Not compatible <i>*Alternative 5" or 8" Rack Extensions (715001913 or 715001914) are available for G2L</i>	No further requirements	LinQ Luggage Rack 715001734
Not compatible <i>*Alternative Gear Grips by Kolpin (715001421) are available for G2L</i>		
LinQ Base 715002350	No further requirements	Not compatible
Not compatible <i>*Alternative Gun Boot Racks (715001918 or 715001919) are available for G2L</i>		



OUTLANDER | RENEGADE

LinQ Accessories with 16" base 

EXPERT CHOICE

LinQ 4.2 GAL [16 L] COOLER

- Rotomolded construction for exceptional rigidity and durability.
- Premium-quality foam insulation for optimal ice retention.
- Marinized for salt water purposes.
- See table for installation location and requirements.

G2, G2S

- 219400964 - Black
- 295100698 - White



LinQ TOOL BOX

- High precision injected HDPE construction provides rigidity and durability.
- 5 Gal (19 L) maximum capacity.
- Weather-resistant, sealed and lockable cover.
- LinQ Cargo Base Kit included (860201806).
- Marinized for salt water purposes.
- See table for installation location and requirements.

G2, G2S

715004301



LinQ DRY BAG

- Fully waterproof roll-top dry bag will securely store and confine your equipment.
- LinQ mounted using heavy-duty rigid plastic base.
- High capacity storage solution 10.6 Gal (40 L).
- Bottom foam liner for additional equipment protection.
- Integrated handle for easy transportation on/off the vehicle.
- LinQ Cargo Base Kit included (860201806).
- Marinized for salt water purposes.
- See table for installation location and requirements.

G2, G2S

715002875



SR 5.5 GAL [21 L] LinQ BAG

- Semi-rigid expandable bag.
- 5.5 Gal (21 L) capacity.
- LinQ Cargo Base Kit included (860201806).
- See table for installation location and requirements.

G2, G2S

860201740



LinQ 4.5 GAL [17 L] SPORT BAG

- 17-liter 4.5 Gal (17 L) capacity.
- Rigid bottom, semi-rigid top.
- See table for installation location and requirements.
- LinQ Cargo Base Kit included.

G2, G2S

860201678





LinQ 12 GAL (45 L)
CARGO BOX

5" (13 CM)
RACK EXTENSION

OUTLANDER | RENEGADE

LinQ Accessories with 36" base 

LinQ 12 GAL (45 L) CARGO BOX

- LinQ mounted for easy on, easy off installation.
- Holds cargo safely and securely while riding.
- See table for installation location and requirements.

G2 (front only for 6x6 & MAX models 2013-2014), G2L, G2S
715003879



LinQ 23 GAL (86 L) TRUNK BOX

- LinQ mounted for easy on, easy off installation.
- Lockable and weather-resistant.
- Holds cargo safely and securely while riding.
- Comfort pads for passenger.
- See table for installation location and requirements.

G2 (except 6x6 models), G2L, G2S
715004923



LinQ 23 GAL (86 L)
TRUNK BOX

EXPERT CHOICE

LinQ 32 GAL (121 L) TRUNK BOXES

Seamless integration with vehicle

- Built from the design stage to specifically match your Can-Am vehicle.
- Totally cohesive design eliminates the need to modify your vehicle in any way.*
- Rear tail light.

Color-keyed panels

- Colored Trunk Box Panels & Camo Decals are available to match your Outlander (sold separately).

Easy quick-attach installation

- Equipped with the LinQ System, the rear trunk box plugs in and out in seconds.
- Instantly transforms your vehicle to suit the need of the moment.

Unparalleled storage

- 32 Gal (121 L) load capacity with contiguous unobstructed space to maximize storage room and access to the trunk's interior.

Built tough

- Made of injection-molded polyethylene, double walled in critical areas.

Dust-proof and weatherproof

- The fully sealed lid protects your belongings from dust, moisture and the elements.

Lockable

- Built-in lockable barrel.



LinQ 32 GAL (121 L) TRUNK BOX

- LinQ Retrofit Adaptor Plate (715001334) is required for G1 models.
- Trunk Box Panels available in many colors to match your vehicle (sold separately).
- See table for installation location and requirements.

G2 (except MAX models & 6x6), G2S

715001747

EUROPEAN VERSION (EC compliant)

- No rear tail light.

715001748

LinQ 32 GAL (121 L) TRUNK BOX FOR OUTLANDER MAX

- Passenger comfort is ensured on active rides as well as longer recreational rides thanks to the ergonomically designed passenger padding comfort-fitted with a portion made of closed cell foam that won't absorb water.
- Very easy to embark even when driver is seated.
- Trunk Box Panels available in many colors to match your vehicle (sold separately).

G2 (MAX models only except 6x6 models)

715001749

EUROPEAN VERSION (EC compliant)

- No rear tail light.

715001750



LinQ 32 GAL (121 L) TRUNK BOX PANELS

- Color panels to match the LinQ 32 gal (121 L) LinQ Trunk Box to your vehicle.

LinQ 32 Gal (121 L) Trunk Boxes

- | | |
|--------------------------|------------------------------|
| ■ 715001391 · Black | ■ 715002984 · Octane Blue |
| ■ 715001392 · Yellow | ■ 715002985 · Manta Green |
| ■ 715001395 · Viper Red | ■ 715002986 · Can-Am Red |
| ■ 715002481 · White | ■ 715006119 · Orange Crush |
| ■ 715002480 · Light Grey | ■ 715006120 · Squadron Green |
| | ■ 715007074 · Tundra Green |

EUROPEAN VERSION (EC compliant)

- No rear tail light
- | |
|----------------------------|
| ■ 715001397 · Black |
| ■ 715001398 · Yellow |
| ■ 715002482 · Light Grey |
| ■ 715002483 · White |
| ■ 715006121 · Can-Am Red |
| ■ 715006122 · Manta Green |
| ■ 715006123 · Orange Crush |
| ■ 715006124 · Viper Red |

CAMO DECALS FOR BLACK TRUNK BOX PANELS

(Not illustrated)

- Camo pattern perfectly matches your camo vehicle.

LinQ 32 Gal (121 L) Black Trunk Box Panel

- | |
|---|
| ■ 715002975 · Mossy Oak Break-Up Country Camo |
| ■ 715001683 · Next G-1 Vista Camo |



715002975



715001683

OUTLANDER | RENEGADE

LinQ Accessories with 36" base 

EXPERT CHOICE

LinQ 11.5 GAL [43 L] AUDIO CARGO BOX

- Mounts on/off easily to hold/carry cargo safely and securely.
- The Bluetooth enabled receiver and 6.5" (16.5 cm) speakers are smartly concealed and integrated in the cover.
- Automatic shut-off function protects your battery by turning the system off after 10 minutes of inactivity.
- Backlit control panel perfect for night riding.
- Water-resistant speakers.
- Delivers the best sound quality on the market to sweeten your ride courtesy of a built-in full range high-efficiency amplifier.
- See table for installation location and requirements.

G2 (front only for 6x6 & MAX models 2013-2014), G2L, G2S
715003018



LinQ 8 GAL [30 L] COOLER BOX

- LinQ mounted for easy on, easy off installation.
- Rotomolded construction provides exceptional rigidity and durability.
- Premium-quality foam insulation for optimal ice retention.
- Integrated, fully-removable compartment protects food.
- Robust rubber latches keep the cover tightly closed.
- Weather-resistant.
- Convenient drain plug.
- See table for installation location and requirements.

G2 (except 6x6 models), G2S

■ 715004778 · Black

G2 (except 6x6 models), G2S

■ 715004698 · Grey



LinQ PREMIUM STORAGE BAG BY OGIO

- Tool-less installation and removal thanks to the LinQ System.
- 17.2 Gal (65 L) capacity semi-rigid cargo bag ideal for carrying anything you need on your vehicle.
- Buckle and elastic closure with a rubber seal that protects dust from entering the bag.
- 3-section lid for partial or full access to your bag.
- Inside separators for optimal bag organization.
- See table for installation location and requirements.

G2 (except 6x6 models), G2L, G2S

■ 715002923 · Black

■ 715003248 · Mossy Oak Break-Up Country Camo



INSIDE SEPARATORS FOR OPTIMAL BAG ORGANIZATION



LinQ LOW PROFILE BASKET

- Low profile, open basket increases cargo space.
- Perfect for easy access to tools, rope, winch and plow accessories.
- Multiple bungee cord and tie-down anchor points.
- Made of impact-resistant injected polypropylene.
- See table for installation location and requirements.

G2, G2L (front only for MAX & 6x6 models), G2S

715004282



EXPERT CHOICE

LinQ HEAVY-DUTY BASKET

- Made of high-strength, low-alloy steel.
- LinQ mount for easy on, easy off installation.
- Can be placed on both front and back racks of vehicle.
- See table for installation location and requirements.

G2, G2L (front only for MAX & 6x6 models), G2S

715001215





LinQ STORAGE BOX
2 GAL (7.5 L)

EASY LOADS IT:
LinQ ACCESSORIES
MOUNT SECURELY
IN SECONDS

OUTLANDER | RENEGADE

LinQ Accessories 

SOFT STORAGE BAG

- 3-section bag.
- Transport gear in a weatherproof bag.
- 11.8 Gal (45 L) capacity soft cargo bag designed with vehicle's rack in mind to maximize potential storage.
- LinQ Luggage Rack (715001734) is required for G2S.

G2, G2L, G2S

■ 715003759 • Black



LinQ ANCHOR ADAPTOR KIT

- Allows the installation of accessories with LinQ base of 16" on LinQ racks.
- Tool-less installation and removal.
- For G2S, the LinQ Luggage Rack (715001734) is required for installation.

G2, G2S

715004960



LinQ BASE

- Made of polypropylene glass fiber.
- Allows you to install LinQ accessories.
- Sold in pack of 4.

G2L

715002350



LinQ REPLACEMENT PARTS

- Unique mounting fastener usable on any LinQ System accessory.
- Tool-less installation and removal.
- Sold in pairs.

715001707



STORAGE 2.6 GAL (10 L) BAG

- Roll-top dry bag for fully protecting your cargo from the elements.
- Fits in rear compartment of your vehicle.

269502121



CARGO & STORAGE



LOG BARS

- Log bars allow you to convert the cargo bed into a perfect transport space for 4' (120 cm) timber.
- The driver's safety is guaranteed by the protective front screen.

G2 (6x6 models only)

715001987



HARD TOP

- The hard top provides a 116 Gal (440 L) cargo box.
- Locking secures your belongings.
- The cover raises assisted by gas cylinders.

G2 (6x6 models only)

715002394



CARGO BOX POOL

- Transforms the flatbed into a large capacity cargo box for increased loading possibilities.
- Made of durable formed HDPE and shaped to maximize cargo space.
- Allows access to vehicle's water-resistant rear compartment.
- Designed for perfect fit and easy installation.

G2L (6x6 models only)

715005256



TAILGATE EXTENSION/DIVIDER

- The sturdy tailgate extension provides a 10" (25 cm) extension to the cargo space.
- Thanks to the longer cargo bed, even large loads pose no problem.
- With the help of LinQ quick locks, the extension also acts as a solid space divider for the cargo bed.

G2 (6x6 models only)

715002017



TARPAULIN

- Fitted to cover all of the items in your cargo box thoroughly.
- Prevents splash from entering cargo box.
- Easily removable for quick access.

G2 (6x6 models only)

715002416



18 GAL (70 L) UTILITY BOX

- Wherever you go and whatever you do, this handy 18 Gal (70 L) utility box is your mobile storage.
- The lid keeps your equipment safe from the elements in all conditions.
- Slides under the flatbed with handles for easy access.

G2 (6x6 models only)

715001999



CARGO BOX NET

- Solid net designed to hook to the bottom of the cargo box for secure and compact confinement of your cargo.

G2 (6x6 models only)

715001371



TAILGATE LIMITER KIT

- 2 L-shape brackets that hold the tailgate open horizontally.
- Keeps tailgate flush with the rest of the flatbed for longer oversized cargo.

G2 (6x6 models only)

715002080



CAN-AM WINDSHIELDS

FACTORY-DESIGNED WIND AND DEBRIS PROTECTION OPTIONS WITH CLEAR BENEFITS FOR EVERY CAN-AM ATV RIDER.



TOOL-LESS

Install base bracket and quickly remove windscreen when needed.

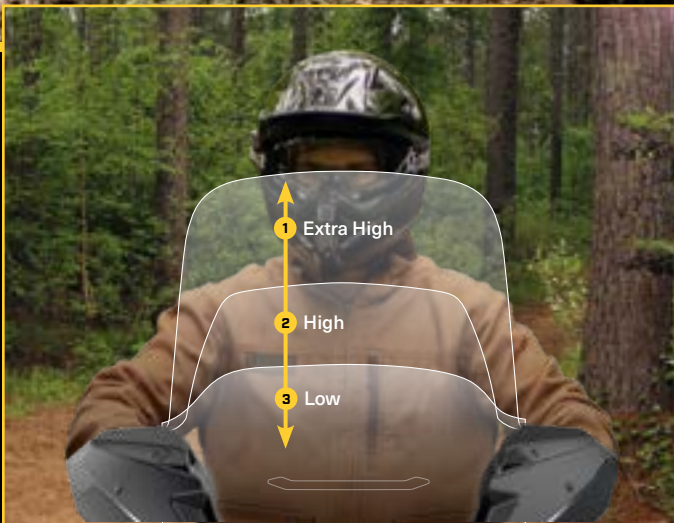

ELEVATED PROTECTION

Pick the windscreen based on the conditions with three different sizes to match your vehicle perfectly.



100% INTEGRATED

Perfectly shaped, built and finished to seamlessly improve the way your ATV cuts through the wind.

CREATE YOUR ULTIMATE WIND PROTECTION IN 3 EASY STEPS

1 CHOOSE A DELUXE FAIRING COLOR

EXPERT CHOICE

DELUXE FAIRING

- Innovative, richly featured wind protection.
- Quick toolless removal once base brackets are mounted on handlebar.
- Two cup holders.
- Ready for GPS mounting kit.

G2 (except X mr & 6x6), G2L

715000935 · Yellow 2000

715001231 · Red Viper

715001232 · Black

- Optional mirrors and auxiliary lighting.
- Requires low, high or extra high windshield.
- Tapered Handlebar Adapter Kit is required for vehicles with 1 1/8" (28 mm) tapered aluminum handlebars.

715002479 · Light Grey

715006125 · Squadron Green

715007073 · Tundra green



CAMO DECALS FOR BLACK DELUXE FAIRING

(Not illustrated)

- Camo pattern perfectly matches your camo vehicle.

Deluxe Fairing

715002976 · Mossy Oak Break-Up Country Camo

715001684 · Next G-1 Vista Camo



715002975



715001684

TAPERED HANDLEBAR ADAPTOR KIT

(Not illustrated)

- Required to install Deluxe Fairing on an Outlander X-TP and on any vehicle equipped with 1 1/8" (28 mm) tapered aluminum handlebars.

Deluxe Fairing

715002470

2 CHOOSE THE WINDSHIELD HEIGHT ACCORDING TO YOUR RIDING STYLE

EXTRA HIGH WINDSHIELD

- 16" (41 cm) windshield provides the ultimate protection against the elements while touring.
- For wind protection and winter applications.
- Tool-less installation and replacement.

Deluxe Fairing

715000936



16" (41 cm)

HIGH WINDSHIELD

- 11" (28 cm) high, for wind protection and winter applications.
- Tool-less installation and replacement.

Deluxe Fairing

715001211



11" (28 cm)

LOW WINDSHIELD

- 6" (15 cm) windshield allows you to keep your vehicle looking sporty while giving you some protection from the elements and the possibility of enjoying directional lighting.
- Tool-less installation and replacement.

Deluxe Fairing

715001227



6" (15 cm)

3 COMPLETE WITH PERFECTLY INTEGRATED ACCESSORIES

AUXILIARY WINDSHIELD LIGHTING

- 2 premium LED spots for Deluxe Fairing for both increased output and directional lighting.
- 1,800 lumens.
- 2 x 10W LED Cree light kit.
- Long-range illumination up to 350' (107 m), drawing less than 1 amp per light.

Deluxe Fairing

715003115



DELUXE MIRROR KIT

- Improved mounting system.
- Wide rear view.
- Perfect fit with your Deluxe Fairing.

Deluxe Fairing

715002353



INTEGRATED AIRFLOW VENT REDUCES AIR TURBULENCE AND ENGINE RUMBLE AT HIGHER SPEEDS FOR LESS BUFFETING AND MORE COMFORT.



OUTLANDER | RENEGADE

WINDSHIELD KITS

- Made of polycarbonate with integrated vent to reduce air turbulence and rumble noise at high speeds for a quieter and smoother ride.
- Quick tool-less removal once base brackets are mounted on handlebar.
- Fits straight and tapered handlebars.
- Improved design for enhanced rigidity.
- Steering Cover (709400939) is required for XT and Mossy Oak models.

1 EXTRA HIGH WINDSHIELD KIT

- 16" (41 cm) windshield.
- For ultimate wind protection and winter applications.

G2, G2L, G2S (except X mr models)
715003023



16" (41 cm)

2 HIGH WINDSHIELD KIT

- 11" (28 cm) windshield.
- For wind protection and winter applications.

G2, G2L, G2S (except X mr models)
715006382



11" (28 cm)

3 LOW WINDSHIELD KIT

- 6" (15 cm) windshield.
- Allows you to keep your vehicle looking sporty while giving you some protection from the elements.

G2, G2L, G2S (except X mr models)
715003021



6" (15 cm)

HANDLEBAR WIND DEFLECTORS

- Rugged injected plastic construction with Can-Am logo.
- Include removable cap for air flow adjustment.
- Mounting kit sold separately.

G2, G2L, G2S

- 715000525 • Black / Yellow
- 715000537 • White / Black
- 715001706 • Black / Black
- 715000733 • Yellow / Black
- 715003811 • Can-Am Red / Black
- 715003812 • Manta Green / Black
- 715003813 • Orange / Black
- 715003814 • Octane Blue / Black
- 715006117 • Squadron Green/Black
- 715006118 • Viper Red/Black



PASSENGER WIND DEFLECTORS

- These wind deflectors fit on the passenger handles and provide greater comfort while riding.
- Easy to install and remove.

G2 and G2L (MAX models only)

715001669



FULL WRAP ALUMINUM MOUNTING KIT

- Lightweight black die cast aluminum construction.
- Includes complete hardware.
- Handlebar wind deflectors sold separately.

G2, G2L, G2S

715001378



SHORT ALUMINUM MOUNTING KIT

- Lightweight black die cast aluminum construction.
- Includes complete hardware.
- Handlebar wind deflectors sold separately.

G2, G2L, G2S

715001379



MIRROR KIT FOR HANDLEBAR WIND DEFLECTORS

- Do not fit with Full Wrap Aluminum Mounting Kit (715001378).
- Sold in pairs.

Handlebar Wind Deflectors

860200080

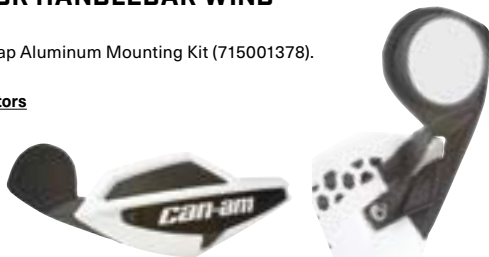

ALUMINUM TAPERED HANDLEBAR

- 7/8" - 1 1/8" (22 mm - 28 mm) tapered handlebar made of 6061-T6 aluminum.
- Includes all hardware, center steering foam and cover.

G2, G2L, G2S

715000550



XT HANDLEBAR PROTECTOR KIT

- Not compatible with Mud Strap (715003053).

G2, G2L

703100352



MIRRORS

- True vision surface 5" x 3" (13 cm x 8 cm).
- Matte finish.
- Stem includes 3/8" (10 mm) thread.

Left - 3/8" (10 mm)

- Bracket (715000190) is required for installation on DS 450.
- Bracket not required for installation on Outlander and Renegade.

709400406

Right - 3/8" (10 mm)

- Bracket (715000190) required except for vehicles with right hand brake.

709400523



COMFORTABLE
DRIVER &
PASSENGER
SEATING
OPTIONS FOR
ALL RIDERS



OUTLANDER

DRIVER BACKREST

- Provides the rider's back with that extra support that makes riding that extra mile way more comfortable.
- Adjusts horizontally to match the driver's height and preference.
- Mounts and locks in firmly onto the vehicle.

G2 (except 6x6 & MAX models)

715003940

**G2 2015 & up, G2L
(MAX models only,
except 6x6 models)**

715003942

G2L (except MAX models)

715003941

**G2 (6x6 models only,
except Max)**

715003611



OUTLANDER MAX PASSENGER SEAT KIT

- Perfect to replace used or damaged passenger seat.

**G2 2015 and up, G2L
(MAX models only)**

715002373



OUTLANDER | RENEGADE

EXPERT CHOICE

LinQ RACK EXTENSION

- Fits front or rear.
- Strong and durable.
- Helps keep cargo securely in place.
- Easy and tool-less installation thanks to the LinQ System.
- Anti-corrosion coating with durable powder coat finish.
- LinQ Luggage Rack (715001734) is required for G2S.

G2, G2S

4" (10 cm)

715001711 • Silver
715001665 • Black

6" (15 cm)

715001712 • Silver
715001671 • Black



4" (10 cm)



6" (15 cm)

OUTLANDER

EXPERT CHOICE

RACK EXTENSION

- Fits front or rear.
- Made of carbon steel.
- Provides tie-down points to secure cargo on racks.
- Easy installation on tubular rack.
- Anti-corrosion coating with durable powder coat finish.

G2L

5" (13 cm)

715001913

8" (20 cm)

715001914



5" (13 cm)



8" (20 cm)

RENEGADE

REAR ALUMINUM RACK

- 30 lb (14 kg) capacity.
- Compact, lightweight aluminum construction.
- Engraved Can-Am logo.
- Stamped 5052 aluminum center plate.
- Easy to install.

G2S

715001360



LinQ LUGGAGE RACK

- Bolt-on rack.
- Enables use of LinQ mounted accessories on the G2S.

G2S (except X mr models)

715001734



OUTLANDER

GUN BOOT RACK

- Made of steel.
- Designed for the tubular rack.
- For use with Gun Boot 6.0 Impact by Kolpin.
- Can be mounted to either side of the vehicle.

G2L (except MAX models)
715001918

G2L (MAX models only)
715001919



GUN BOOT 6.0 IMPACT⁺ BY KOLPIN⁺

- Extra room for pistol-grip-type weapons and small bipods.
- Easily fits firearms up to 51" (130 cm) in total length.
- Provides ample room for 2 3/8" (60 mm) scopes.
- Hatchback design allows easy access.
- Ergonomically designed handle and molded attachment points for sling.

G2, G2L
715001419



- Snap-close cover with locking capability.
- Designed to accommodate left and right hand bolt-action rifles and shotguns.
- Includes removable, shock absorbing foam and nylon Impact liner for superior interior protection.
- Requires appropriate mounting kit for installation.

LinQ GUN BOOT RACK

- (Not illustrated)
- This lightweight Gun Boot Rack can be mounted on either side of your Outlander using the tool-less LinQ System.
 - For use with Gun Boot 6.0 Impact by Kolpin.

G2 (except MAX, 6x6 & X mr 1000)
715002112 · Black

G2 (MAX & X mr 1000 models only)
715002113 · Black

MULTI-FIT HOLDER

- Open U-shaped bracket for carrying tools (shovel, axe) and hunting weapons (rifle, bow) that are safely secured, but easily accessible.
- Easy installation on tubular rack, extension racks, basket or bumpers.
- For G2, the LinQ Rack Extension (715001711) is required.
- Sold in pairs.

G2, G2L
Single
715002354

Double
715001945



OUTLANDER | RENEGADE

GEAR GRIPS BY KOLPIN

- Durable, flexible grips cushion and protect while providing a custom fit for a variety of items from 1" to 4" (2.5 cm to 10 cm) in diameter.
- Heavy-duty design for carrying bows, fishing poles, rakes, farm tools and more.
- Quick-release button opens grip quickly for easy access to gear.
- Heavy-duty base system built for the toughest adventures.
- Easy installation on tubular racks, extension racks, brackets or bumpers.
- Sold in pairs.

G2L
715001421



LinQ MOUNTED GEAR GRIPS BY KOLPIN

- (Not illustrated)
- Same features as Gear Grip by Kolpin (715001421).
 - Make transporting your tools a snap by combining the Gear Grips with the LinQ System.
 - 360° orientation.
 - LinQ Luggage Rack (715001734) is required for G2S.

G2, G2S
715001351

LinQ TOOL HOLDER

- Ultra-versatile tool holder.
- Convenient swivel-latch allows tools to be stored in any orientation.
- LinQ Luggage Rack (715001734) is required for G2S.
- Sold in pairs.
- Not compatible inside the Cargo Box.

G2, G2S, G2L
715003059



HMWPE SKID PLATES

OUTLANDER | RENEGADE

Our Plastic Plates glide smoothly and silently over obstacles, offering great protection in rough terrain. Made of ¼" (6 mm) thick abrasion-resistant thermoformed High Molecular Weight Polyethylene (HMWPE).

- ✓ Lighter than aluminum
- ✓ Superior stress crack resistance
- ✓ High impact strength

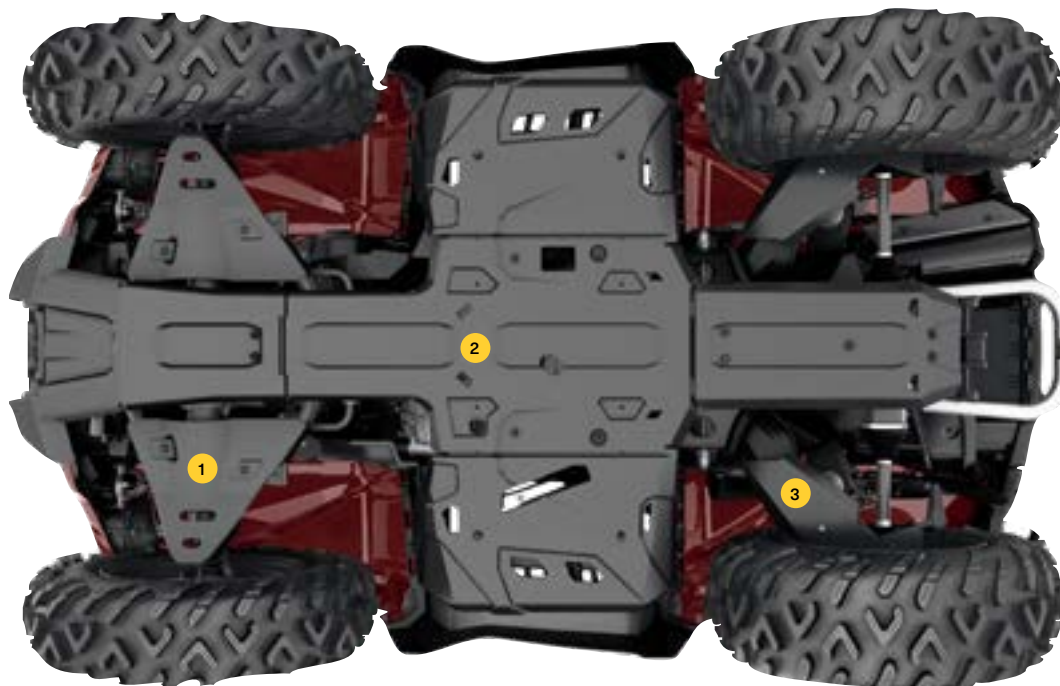

715004806

G2						G2L		G2S	
2016 & PRIOR		2017-2018		2019 & UP				2017-2018 MODELS	2019 & UP
Except MAX & X mr 1000R models	MAX & X mr 1000R models only	Except Max & X mr 1000R models	MAX & X mr 1000R models only	Except MAX & X mr 1000R models	MAX & X mr 1000R models only	Except MAX models	MAX models only		



FULL PROTECTION KIT										
HMWPE Skid Plate Protection Kit	715004214	715004215	715004209	715004210	715004806	715004807	715004211	715004212	715004213	715004809

INDIVIDUAL HMWPE SKID PLATES											
1	A-Arm Protectors	715002924	715002924	715002924	715002924	715004822	715004822	715002924	715002924	715002924	715004822
2	Underbelly Plates <small>Footwell portion not compatible with Renegade Xmr</small>	715002926	715002927	715002926	715002927	715002926	715002927	715002928	715002929	715002974	715002974
3	Trailing Arm Protectors	715002925	715002925	715003466	715003466	715004823	715004823	715003466	715003466	715003466	715004823

ALUMINUM SKID PLATES

OUTLANDER

For ultimate durability and strength, all our Aluminum Skid Plates are made with 3/16" (4.5 mm) thick High Strength 5052 H32 Aluminum.

-  Ultimate durability
-  High strength



715004197

	G2						G2L	
	2016 & PRIOR		2017-2018		2019 & UP		ANY YEAR	
	Except MAX & X mr 1000R models	MAX & X mr 1000R models only	Except MAX & X mr 1000R models	MAX & X mr 1000R models only	Except MAX & X mr 1000R models	MAX & X mr 1000R models only	Except MAX models	MAX models only
FULL PROTECTION KIT								
Aluminum Skid Plate Protection Kit	715002137	715002138	715004197	715004198	715004804	715004805	715004199	715004200
INDIVIDUAL ALUMINUM SKID PLATES								
1 A-Arm Protectors	715001667	715001667	715001667	715001667	715004820	715004820	715001667	715001667
2 Front Skid Plate	715000926	715000926	715000926	715000926	715000926	715000926	715001906	715001906
3 Central Skid Plate	715002078	715002078	715002078	715002078	715002078	715002078	715002078	715002078
4 Footwell Protector Plates	715000922	715000922	715000922	715000922	715000922	715000922	715000922	715000922
5 Trailing Arm Protectors	—	—	715003741	715003741	715004821	715004821	715003741	715003741
6 Rear Differential Protectors	715000920	715000920	715000920	715000920	715000920	715000920	715000920	715000920
7 Rear Skid Plate	715002028	715002029	715002028	715002029	715002028	715002029	715002028	715002029

ALUMINUM SKID PLATES

RENEGADE

For ultimate durability and strength, all our Aluminum Skid Plates are made with 3/16" (4.5 mm) thick High Strength 5052 H32 Aluminum.

- ✓ Ultimate durability
- ✓ High strength



715004201

		G2S		
		2016 & PRIOR	2017-2018	2019 & UP
FULL PROTECTION KIT				
ALUMINUM SKID PLATE PROTECTION KIT <small>Not compatible on X mr models</small>		715002139	715004201	715004808
INDIVIDUAL ALUMINUM SKID PLATES				
1	A-Arm Protectors	715001667	715001667	715004820
2	Front Skid Plate	715000925	715000925	715000925
3	Central Skid Plate	715002078	715002078	715002078
4	Footwell Protector Plates <small>Not compatible on X mr models</small>	715001359	715001359	715001359
5	Trailing Arm Protectors	—	715003741	715004821
6	Rear Differential Protectors	715000920	715000920	715000920
7	Rear Skid Plate	715002028	715002028	715002028

HMWPE & ALUMINUM SKID PLATES

OUTLANDER 6x6

Our Plastic and Aluminum Plates glide smoothly and silently over obstacles, offering great protection in rough terrain.

HMWPE

Made of 1/4" (6 mm) thick abrasion-resistant thermoformed High Molecular Weight Polyethylene (HMWPE).

- ✓ Lighter than aluminum
- ✓ Superior stress crack resistance
- ✓ High impact strength

ALUMINUM

Made with High Strength 3/16" (4.5 mm) thick 5052 H32 Aluminum.

- ✓ Ultimate durability
- ✓ High strength

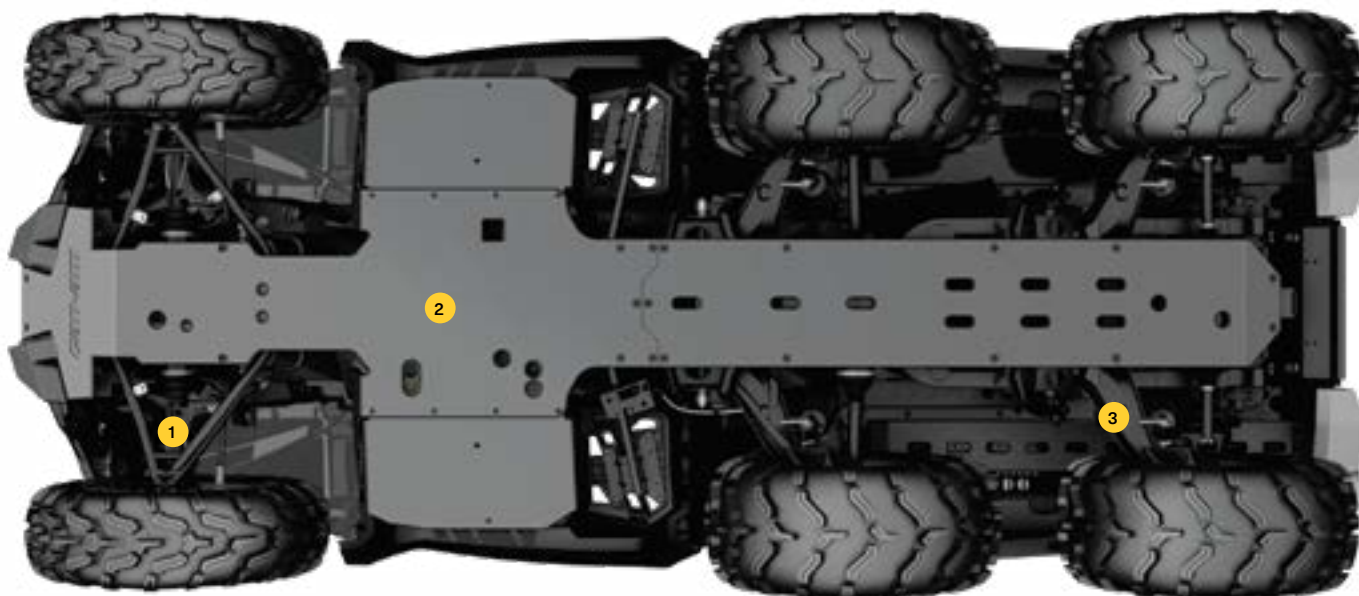

		G2 6x6			G2L 6x6
		2016 & PRIOR	2017 - 2018	2019 & UP	ANY YEAR
INDIVIDUAL HMWPE SKID PLATES					
1	HMWPE A-Arm Protectors	715002924	715002924	715004822	715002924
2	HDPE Full Underbelly Skid Plate	715003646 (Except MAX) 715003647 (MAX only)	715003646 (Except MAX) 715003647 (MAX only)	715003646 (Except MAX) 715003647 (MAX only)	715005259 (MAX only)
3	HMWPE Trailing Arm Protectors	715002925	715003466	715004823	715003466
INDIVIDUAL ALUMINUM SKID PLATES					
1	Aluminum A-Arm Protectors	715001667	715001667	715004820	715001667
2	Aluminum Full Underbelly Skid Plate	—	—	—	—
3	Aluminum Trailing Arm Protectors	—	715003741	715004821	715003741

CAN-AM BUMPERS

THE STRENGTH TO ENDURE AND THE CHARACTER TO WEAR WELL—
OUR BUMPERS ARE READY FOR IT.



**DURABLE
TEXTURED FINISH**
For long life and better
resistance to scratches
and corrosion.



HEAVY-DUTY LOOKS

Real capability—with a durable fit and finish
you'll just have to age yourself.



100% INTEGRATED

Perfectly shaped, built and finished to seamlessly improve
the way your ATV cuts through the wind.

OUTLANDER

NEW EXPEDITION FRONT BUMPER

- Made of 1.5" profiled steel tubes for complete protection of the vehicle's front.
- Protects and doesn't obstruct the vehicle's headlights.
- Integrated mounting spots for lights.
- Inside and outside anticorrosion coating with a durable powder coat finish.

G2, G2L
715007233



NEW EXPEDITION REAR BUMPER

- Made of 1.5" profiled steel tubes for a complete protection of the vehicle's rear.
- Protects and doesn't obstruct the vehicle's taillights.
- Inside and outside anticorrosion coating with a durable powder coat finish.
- G2 base and DPS rear bumper installation requires 705008164 and 705008165.

G2, G2L
715007234



OUTLANDER | XT BUMPERS

- Provide additional protection against obstacles.
- Tough and durable, can be added on base Outlander model to convert vehicle into XT model.

XT FRONT BUMPER

G2
715004837



- Standard on XT, X TP, Mossy Oak and Limited models.
- Large tube construction with textured black finish and metal corners.

XT REAR BUMPER

G2
715004920



XT FRONT BUMPER

- Winch compatible.
- Large tube construction.
- Protects vehicle against obstacles.
- Standard on XT models.

G2L
715001910



XT REAR BUMPER

G2L
715001911



OUTLANDER

BODY SIDE PROTECTOR

- The heavy-duty fender guard designed to pull double duty, protecting your ATV and also enhancing the look of your ATV.
- Made tough and designed to deliver a rugged appearance, this fender guard offers full side protection for farmer, rancher and forestry applications.
- Built of durably bold 1.25" (3 cm) diameter steel-tube construction, with inside and outside anti-corrosion coating with durable powder coat finish.
- Not compatible with Self Clearing Footwell.
- XT Front and Rear Bumpers or Rancher Front and Rear Bumpers are required for installation.
- Requires Body Side Protector Extensions (715003460) for installation on MAX models.

G2, G2L, with Rancher bumpers (except X mr & 6x6 models)
715003459

G2 with XT bumpers (except 6x6 models)
715004940

G2L with XT bumpers (except X mr & 6x6 models)
715003614

BODY SIDE PROTECTOR EXTENSIONS

(Not illustrated)

- This specially designed extension for the Body Side Protector is made specifically to fit and seamlessly integrate into the look of Outlander MAX models.

G2, G2L (MAX models only)
715003460





**WORK AND MOVE
CONFIDENTLY
WITH HEAVY-DUTY,
HERD-FRIENDLY
PROTECTION OPTIONS**

OUTLANDER | COMPLETE RANCHER PROTECTION KIT

- These heavy-duty bumpers and fender guards are designed to pull double duty: protect your ATV and anything it comes in contact with, while also enhancing the look of your ATV.
- Made tough and designed to deliver a rugged appearance, together they offer front, rear and full side protection for farmer, rancher and forestry applications.
- Requires Body Side Protector Extensions (715003460) for installation on MAX models.

This kit includes:

- Rancher Front Bumper (715003461)
- Rancher Rear Bumper (715003462)
- Body Side Protector (715003459)

**G2, G2L (except X mr & 6x6 models)
715003463**



RANCHER FRONT BUMPER

RANCHER FRONT BUMPER

- The low front end protection and plates allow you to use your ATV within cattle herds and guard the safety of both the vehicle and the animals.
- The flat front portion facilitates gently prodding cattle or pushing light objects, e.g. closing a fence.
- The full frontage coverage extends to provide an extra layer of defense to your headlights and radiator.
- Inside and outside anti-corrosion coating with durable powder coat finish.
- Not compatible with track systems, plows and front hitch.

**G2, G2L (except X mr models)
715003461**



RANCHER REAR BUMPER

- Ideal for using your ATV within cattle herds and guard the safety of both the vehicle and the animals.
- Coverage extends to provide an extra layer of defense to your tail lights.
- Inside and outside anti-corrosion coating with durable powder coat finish.
- Not compatible with track systems.

**G2, G2L (except 6x6 models)
715003462**



OUTLANDER

EXTREME FRONT BUMPER

- Ultra-sturdy build.
- Enhances front-vehicle protection.
- Compatible with XT Front Bumper.
- Fits the Apache™ 360 Track System (when side panels are removed).

G2

- Not compatible with Front Hitch.

715001286

G2L

715004279



715001286



715004279

FENDER FLARES

- Kit designed to deliver extra protection from dirt and debris, therefore a must if you enjoy riding in the mud.
- Made of injected plastic that hugs your vehicle fenders perfectly.
- Gives vehicle added flair for that rugged cool look.
- Includes front and rear extensions and all mounting hardware.

G2 2012-2018 (except with 30" tires) (except 6x6 models)

715001764

G2 2019 & up (with 30" tires) (except 6x6 models)

- Standard on G2 X mr 1000R.

715004250

G2L

- Not compatible with European vehicles.

715001909

G2L European vehicles only 2015 & up

715004487



FENDER FLARE EXTENSIONS

- Block terrain debris from kicking up onto you as you ride or damaging your vehicle thanks to these extra-large Fender Flare Extensions, which also include mud flaps for added protection from mud/snow, especially when riding with track kits.
- Made of High Molecular Weight Polyethylene (HMWPE) for advanced abrasion resistance.
- Include front and rear extensions.

G2 (except 6x6 models)

- Must be used with Fender Flare for G2 (715001764).

715005111

G2L

- Must be used with Fender Flare for G2L (715001909).

715003615



MUD FLAPS

- Keeps mud, snow and debris out of cargo area and protects trailer and vehicles behind you.
- Adds aesthetic appearance to your vehicle.
- Requires stock fender flare.
- Sold in pairs.

G2 (with stock fender flares)

715007089



FLATBED PROTECTION TUBES

- Bolt-on bumpers for the sides of the 6x6 flatbed.
- Protect the exterior plastic components of the flatbed from rocks, trees and other obstacles when traversing enclosed areas or loading cargo onto the bed.

G2 (6x6 models only)

715002030

G2L (6x6 models only)

715005266



715002030



715005266

RENEGADE

FENDER FLARES

- Integrated extended Fender Flares for sporty look and full body protection from dirt and water.
- Include front and rear extensions and all mounting hardware.

G2S (except X mr models)

705012695



RENEGADE EXTREME FRONT BUMPER

- Enhanced vehicle front protection.
- Required as a mounting point for Radiator Relocator (715001929).

G2S

715002469



LIGHTS & ELECTRICAL



OUTLANDER | RENEGADE

EXPERT CHOICE

HEATED GRIPS & THUMB THROTTLE COMBO

• Not compatible with Intelligent Throttle Control (ITC).

G2, G2L, G2S (except 2020 models equipped with 850 engine and 2019 & up models with 1000R engine, T Category models)

Wiring Cable (710004567) is required for installation on G2 and G2L.

715003250

• Compatible with Intelligent Throttle Control (ITC).

G2, G2L, G2S (2020 models equipped with 850 engine and 2019 & up models with 1000R engine, T Category models)

715004815



1 LED dimmer facilitates reading temperature settings.

2 4 temperature settings with individual controls for thumb and grips. Returns to previous heat setting.

3 One-touch shutdown.

WIRING CABLE

(Not illustrated)

• Required for installation of Heated Hand Grips & Throttle Combo.

G2L

710004567

HEATED VISOR OUTLET

- Strategically positioned on vehicle to maintain your agility.
- Optional visor outlet that delivers fog-free riding.
- Quick and easy installation.
- Sold individually.
- Heated Visor not included.

G2, G2L

715001246



OUTLANDER

HEATED PASSENGER GRIPS & VISOR OUTLET

- Replace your stock passenger handles.
- Dual temperature switch integrated into seat arm for 3-zone heated handles and grips.
- Heated visor outlet integrated into seat arm.

G2, G2L (MAX models only)

715001926

G2 (2013-2014) (MAX models only)

715002116



NEW SEAT HEATER

- 25 W seat heater delivers chill-free riding comfort.
- One temperature only.
- Heated pad and electrical harness only.
- Durable seat cover (715007212) is required for the installation.

G2, G2S, G2L

715007211



NEW HEAVY-DUTY SEAT COVER

- Heavy-duty materials to cover and protect the seat.
- Abrasion- and tear-resistant.
- Simply installs by stretching around the original seat; the elastic hold the cover securely in place.

G2, G2S, G2L

715007212



OUTLANDER | RENEGADE

ELECTRONIC DEVICE HOLDER

- Robust injected-polypropylene construction allows for the right fit and easy installation.
- Adjustable unit safely holds smartphones or small tablets with a length or width measuring between 2.9" (7.5 cm) and 5.1" (13.0 cm) with or without protective case.
- Integrated storage (0.6 Gal / 2.1 L).
- Guiding wire grooves to pass charging cable through the lid.
- Possibility of relocating 12V power outlet or installing USB outlet in storage compartment (USB power outlet sold separately).
- Not compatible with windshields and Snorkel Kit.

G2, G2L (except 6x6 & X mr models)
715004919



10" (25 CM) DOUBLE STACKED LED LIGHT BAR (60 WATTS)

- Equipped with 12 5W Cree LEDs.
- 5,400 lumens.
- Rugged and waterproof.
- Packs a big punch for its size.
- EC compliant.
- Expedition Front Bumper (715007233) and Light Power Cable (715007275) required for installation.

G2, G2L
715002933



BLUETOOTH HANDLEBAR SOUNDBAR BY MTX

- Bluetooth speaker with the unbeatable convenience of fingertip control.
 - Rugged IP66-rated weather-resistant speaker designed for outdoor use.
 - Driven by 150 watts of quality audio power.
 - Seamless integration and operation from Bluetooth enabled devices.
 - Includes input, ground and ignition wires, plus auxiliary port and 3.5" (8.89 cm) connector cable.
 - Not compatible with XT Handlebar Protector Kit.
- Note: We recommend you use 320 Kbps MP3 - 192-256 Kbps AAC or AIFF, WAV formats to match the potential of the speaker. More compressed formats will probably have degraded sound quality.

G2, G2L, G2S
219400840



3.5" (9 CM) LED LIGHTS (2 X 14W)

- 14W LED lights producing 1,260 lumens each.
- Equipped with 6 high power LEDs in a heavy-duty die cast aluminum housing.
- Features 2 attachment points — if one attachment point fails due to a collision, rotate to the next channel point and re-mount the light.
- Sold in pairs.
- EC compliant.

G2, G2L



LED DRIVING LIGHTS

- Spot lens for a narrow and long light beam spread, ideal when driving at higher speeds.
- Expedition Front Bumper (715007233) and Light Power Cable (715007275) required for installation.

715003666

LED FLOOD LIGHTS

- Flood lens for a wide light beam spread, ideal for working applications like plowing or for cornering, dusty or foggy riding conditions.

715003665

LIGHT POWER CABLE

(Not illustrated)

- Required for installation of the 10" (25 cm), 15" (38 cm) single and double stacked LED light bars, and the 4" (10 cm) round LED lights.
- For bumper and roof mounting locations.

G2, G2L
715007275

USB POWER OUTLET KIT

- Recharges your electronic devices while riding* (smartphone, MP3, heating gear, etc.).
 - Dual port USB connectors.
- *The power outlet is not capable of recharging all device types while riding.

G2, G2L, G2S
219400510



MULTI POSITION LIGHT MOUNT KIT

- Multi-position plastic clamps that fit on various tubing sizes: 0.75" to 1.5" (19 mm to 38 mm).
- Required for the installation of the 2" (5 cm) Square LED Lights (2 x 10W).
- Kit includes tube clamp mounts and power cables.

G2 (except X xc), G2L, G2S
715004274





ALL LED LIGHTS ARE NOT CREATED EQUAL. BAJA DESIGNS LIGHTS ARE COVERED BY A LIFETIME WARRANTY.



OUTLANDER

EXPERT CHOICE

BAJA DESIGNS HIGH BEAM KIT

- Thanks to their direct bolt-on and plug-and-play installation right into the original high beam location, upgrading from your stock high beam lights to these powerful Baja Designs Squadron Pro LED Lights becomes child's play.
- Each spot is equipped with 4 Cree LEDs producing 4,900 lumens at 40 watts.
- Driving/Combo light pattern for smooth blend of light for both near field applications and distance.

G2
715004284



OUTLANDER | RENEGADE

2" [5 CM] SQUARE LED LIGHTS (2 X 10 WATTS)

- 2 x 900 lumens 10W LED Cree light kit.
- Long-range illumination up to 350' (107 m), drawing less than 1 amp per light.
- Multi-Position Light Mount Kit is required for installation.
- Not EC compliant.

G2 (except X xc), G2L, G2S
715004293



AUXILIARY WINDSHIELD LIGHTING

- 2 premium LED spots for Deluxe Fairing for both increased output and directional lighting.
- 1,800 lumens.
- 2 x 10W LED Cree light kit.
- Long-range illumination up to 350' (107 m), drawing less than 1 amp per light.

Deluxe Fairing
715003115



RAM⁺ LED SPOTLIGHT

- 540 lumens LED light (9W) heavy-duty spotlight standard-equipped with 1" (2.5 cm) diameter rubber-coated double ball and socket system.

G2, G2L, G2S
710005423



RENEGADE

CENTER CONSOLE DAY LIGHT

- Mountable on top end of center console.
- Enhances look of vehicle.

G2S (except X mr)
715000691



OUTLANDER | RENEGADE

JUMP STARTER

- IPX3 water-resistant and enclosed output ports.
- 4 LED battery indicators for easy read on battery charge level.
- Compact design, will conveniently fit in your backpack, glove box or any other storage compartment.
- Quickly starts vehicles in emergencies.
- Great for powersport vehicles, motorcycles and 4 and 6 cylinder vehicles.
- 2.4A + 1A/5V USB ports for fast charging of all USB devices, including smartphones, MP3 players and tablets.
- Smart cable provides protection against reverse polarity, short circuit, low voltage, high temperature and reverse charging.
- Built-in LED light (3 modes).
- Content: 300CA jump starter, SA858 smart cable clamp, MC-USB to USB charging cable, travel bag, user manual.

715005062



QUICK CONNECT BATTERY CABLE

- Quickly and easily connect and charge different items with your charger.
- Included in the Battery Charger/Maintainer (715005061).
- Sold individually.

715005408



QUICK CONNECT CABLE WITH BATTERY INDICATOR

- Quickly and easily connect and charge different batteries with your charger.
- 3-color LED indicator provides constant battery health indication.
- Sold individually.

715006055



CANADIAN MAP FOR GARMIN MONTANA 680T GPS

(Not illustrated)

- Additional and readily-programmable Canadian basemap for Garmin Montana 680T GPS system.
- Requires Garmin Montana 680T GPS (715002830).

710005065

GPS RAM MOUNT FOR HANDLEBAR

- Convenient bracket for installing the Garmin Montana GPS (not included) onto your unit's handlebar.

G2, G2L

715001985



GARMIN[®] MONTANA[®] 680T GPS

- Rugged and waterproof, the Montana 680T is element-proof.
- 4" (10.2 cm) dual-orientation, sunlight-readable touchscreen and glove-friendly touchscreen display, to give you vivid colors and high-resolution images.
- 8-megapixel autofocus camera automatically geotags photos.
- Tracks both GPS and GLONASS satellites for improved positioning and typically faster fixes.
- Preloaded TOPO maps, plus 1-year BirdsEye Satellite Imagery subscription.
- 3-axis compass with barometric altimeter.
- Specific GPS cradle included (vehicle mounting kit required).
- Includes a preloaded map for US.

G2, G2L, G2S

715002830



European Version

- EC compliant.
- Includes preloaded European recreation maps.

715003456



WINCHES



OUTLANDER | RENEGADE | WARN† VRX

- Extreme IP68-rated waterproof sealing keeps the elements out.
- Durable all-metal construction.
- Black powder-coated finish and stainless steel fasteners for corrosion resistance.
- Robust new clutch design based on 70+ years of WARN 4WD hub lock know-how.
- Load-holding brake for great control.
- Smooth and reliable all-metal three-stage planetary gear train.

- Handlebar-mounted rocker control (wired or wireless remote sold separately).
- Limited lifetime warranty (mechanical), 3-year warranty (electrical).
- Mounting plate (715000927) is required for G2S.
- Wire harness (715002453) is required for G2L.
- EC compliant

WARN VRX 25

- Pulling strength capability of 2,500 lb (1,134 kg).
- 50 ft. of 3/16" (15 m of 4.8 mm) wire steel cable.
- Roller fairlead.

G2, G2L, G2S
715006107



WARN VRX 35

- Pulling strength capability of 3,500 lb (1 588 kg).
- 50 ft. of 3/32" (15 m of 5.5 mm) wire steel cable.
- Roller fairlead.

G2, G2L, G2S
715006108



WARN VRX 35-S

- Pulling strength capability of 3,500 lb (1 588 kg).
- 50 ft. of 3/16" (15 m of 4.8 mm) synthetic rope.
- Cast aluminum fairlead.

G2, G2L, G2S
715006109



OUTLANDER | CAN-AM HD

- Heavy-duty 4-way roller fairlead.
- Ergonomic clutch handle.
- Rugged all-steel gears and bushings provide more torque and longer life.
- Automatic 100% load-holding brake.
- Sealed solenoid for all-weather protection.
- Wired Remote Control sold separately.
- Weather sealed handlebar mounted switch.
- EC compliant.
- Mounting plate (715000927) is required for G2S.
- Wire harness (715002453) is required for G2L.

CAN-AM HD 2500 WINCH

- Pulling strength capability of 2,500 lb (1,134 kg).
- 50 ft. of 3/16" (15.2 m of 4.8 mm) wire steel cable.

G2, G2L
715006414



CAN-AM HD 3500 WINCH

- Pulling strength capability of 3,500 lb (1,588 kg).
- 50 ft. of 3/32" (15.2 m of 5.5 mm) wire steel cable.

G2, G2L
715006415



OUTLANDER | RENEGADE

WIRELESS REMOTE CONTROL

- The system is quick and easy to install, thanks to a wiring harness with an integrated antenna and all necessary mounting hardware.
- The system allows you to operate your winch from anywhere within a 50' (15.2 m) radius, increasing your recovery options.
- All components are weatherproof.

Warn winches
715002542



WIRED REMOTE CONTROL

- This kit allows winch owners to add the hand-held remote to their winch.
- EC compliant.

For ATVs with handlebar winch remote socket
710002270

NEW Can-Am WARN winches
• Includes Warn Remote Control (710001002) and Winch Remote Control Socket (715003651).
715006378

ATVs without the winch remote socket
• Side panel Remote Socket (715003651) is required.

Can-Am HD winches
710007050



WINCH ACCESSORIES KIT

- Get the most out of your winch.
- Double your pulling power, change your pulling direction and keep your winch in proper working order.
- Includes tree straps, snatch block, shackle and winching gloves.

715002409



WARN HAWSE FAIRLEAD

- Double powder-coated construction.
- Required to use the Synthetic Winch Cable (715004254) on Warn winches.
- To be used with synthetic winch cables only.

Warn winches
715007698



ROLLER FAIRLEAD

- Features top, bottom and side rollers for less cable wear and smoother operation from any direction for easier winching.

Warn winches
715007699

Can-Am HD winch
710007459



HOOK WITH SAFETY LATCH & STRAP KIT

- Heavy-duty winch-rope hook with stainless steel snap.
- Includes a nylon safety strap.

Can-Am HD winches
705014949



REPLACEMENT WIRE ROPE

- Play it safe, always carry a replacement wire rope.
- 3,500 lb (1,588 kg) pulling strength.

Ask your dealer or visit can-amoffroad.com for price details.

Can-Am HD
• 50 ft. of 3/16" (15.2 m of 4.8 mm) wire rope.
705014983 705014984

ATV Warn winches
• 50 ft. (15.2 m) aircraft grade steel wire.
• 7/32" (5.5 mm) diameter.
715006256



SYNTHETIC WINCH CABLE

- Easier to manipulate than steel cable.
- Replaces the original cable on any factory installed Warn winch or sold as an accessory by BRP.
- Kit includes synthetic rope and rock guard sleeve.
- Always use with the new Hawse Fairlead (715007698).
- 50 ft. (15.2 m).
- 3,500 lb (1,588 kg) pulling strength.

ATV Warn winches
715004254



WINCH MOUNTING PLATE

- Adds functionality to your Renegade.
- Fits Can-Am winches by Warn.

G2S
715000927



WARN REMOTE SOCKET

- (Not illustrated)
- Winch remote socket, located on side panel, is required for wired remote control.

715003651

WINCH WIRE HARNESS

- (Not illustrated)
- Required plug-and-go wiring to install Warn winch only.
 - Not required for Can-Am HD winches.

G2L
715002453

HARDWARE ADAPTER KIT

- (Not illustrated)
- Required to install Warn Winch Kit (715006107, 715006108, 715006109) on 2016 and up models.
 - Required to install Can-Am HD 2500 Winch (715006414) and Can-Am HD 3500 Winch (715006415) on G2L 2017 and up models.

715003477

HITCHES

ADD TOWING CAPACITY
FOR ALL YOUR UTILITY
HARD WORK

OUTLANDER | RENEGADE

FRONT & REAR HITCH DRAWBAR

- Standard on 2" (5 cm) receiver hitch.
- It offers 1,500 lb (680 kg) of towing capacity.
- Hitch ball not included.

G2, G2L, G2S
715000972

European Version

- Drawbar with 2" (5 cm) hitch ball.
- 705208131 (T Homologated)



RUBBER RECEIVER PLUG

- Rubber cap for 2" (5 cm) hitch receiver.
- 705204503



REAR HITCH

- E-coat finish.
- Fixed hitch ball mounting bracket.
- Provides fixed mounting point for trailer ball to provide vehicle with towing capabilities.
- This hitch offers 1,500 lb (590 kg) of towing capacity.
- Hitch ball not included.

G2, G2L (except 6x6 models), G2S
715001925



REAR RECEIVER HITCH

- E-coat finish.
- Does not affect ground clearance.
- Trailer ball not included.
- On 4X4 use, this hitch offers 1,500 lb (680 kg) of towing capacity.
- On 6x6 use, this hitch offers 1,654 lb (750 kg) of towing capacity.
- Compliant with European T regulations.
- Not compatible with rear bumpers and G2L models.

G2S 2012 with 800R or 1000 engines
G2S 2013 & up, G2L & G2
715005186



FRONT RECEIVER HITCH

- Front receiver hitch for Outlander with or without a winch.
- This hitch offers 1,500 lb (590 kg) of towing capacity.
- Allows you to maneuver your trailer easily in tight, confined areas.
- Hitch bar sold separately.
- Not compatible with Extreme Front Bumper, Rancher Bumper and ProMount Plows.

G2
715000921



PERFORMANCE

BELIEVE IT: YOUR
RENEGADE IS A
FEW MODS AWAY
FROM BEING A TRUE
MUD-READY BEAST

- **RENEGADE SNORKEL KIT**
- **RENEGADE RADIATOR RELOCATOR KIT**
- **MUD STRAP**

RENEGADE

RENEGADE SNORKEL KIT

- Comprehensive kit.
- Extended air intakes and CVT exhaust.
- CVT outlet integrates into pod cover.
- Ideal for muddy conditions.

G2S (2020 & prior)
715006000

G2S (2021 & up)
715007083



RENEGADE RADIATOR RELOCATOR KIT

- Relocates radiator to top mount position.
- Prevents cooling performance loss in muddy conditions.
- Uses existing radiator.
- Includes support, hardware and hoses.
- Engineered for easy cooling system bleeding and maintenance.
- Radiator not included.
- Renegade Extreme Front Bumper (715002469) required for installation (except X mr).

G2S
715001929



OUTLANDER | RENEGADE

MUD STRAP

- Convenient sturdy grab-handle.
- Lets drivers redistribute their weight for improved traction in demanding conditions.
- Not compatible with XT Handlebar Protector Kit (703100352).

G2, G2L, G2S
715003053



RADIATOR PROTECTOR

- Metal shield that mounts over radiator face, providing protection from stones and branches.

G2, G2S (except G2S with 500 engine)
715001744

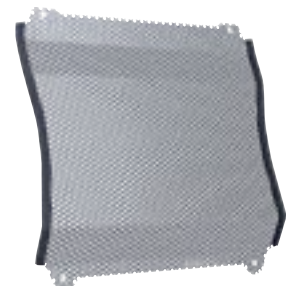



OUTLANDER

EXPERT CHOICE

OUTLANDER SNORKEL KIT

- Comprehensive kit.
- Extended air intakes and CVT exhaust.
- CVT outlet integrates into pod cover.
- Must be installed on a vehicle without XT Handlebar Protector Kit.
- Ideal for muddy conditions.
- For 6x6, appropriate gauge support is required for best fit and finish.
- Not compatible with windshields.

G2 2015 & up, G2L (except X mr)

715005999

G2 (2012-2014 only)

715001730

G2 (X mr models only),

G2L (X mr models only)

- Raised horn only.
- Provides higher intake.
- For best fit and finish, appropriate gauge support is required.

715002518



OUTLANDER RADIATOR RELOCATOR KIT

- Relocates radiator to top mount position.
- Prevents cooling performance loss in muddy conditions.
- Uses existing radiator.
- Includes support, hardware and hoses.
- Engineered for easy cooling system bleeding and maintenance.
- Radiator not included.

G2, G2L

715001930



X MR TRACTION PLATES

- Provide extra foot grip for driver when riding in extreme mud conditions.
- Help driver maintain ideal riding position to maximize vehicle traction.
- Made of aluminum.
- Not meant for a passenger.

G2 (MAX models only), G2L

715001752



EXPERT CHOICE

SELF-CLEARING FOOTWELLS

- Made from aluminum.
- Replace original footwells.
- Feature large evacuation ports to avoid mud and snow accumulation in footwells.
- Aggressive design for improved traction.
- Not compatible with Body Side Protectors.
- Sold in pairs.

G2 2015 & up, G2L

715004759



FOOTPEG KIT

- Provides maximum integrated grip and more stability during vigorous riding.
- Kick-up end generates added grip during hard cornering.
- Made of aluminum.
- Sold in pairs.

G2, G2L

715001131





YOSHIMURA GIVES YOU THE EDGE WITH MORE PERFORMANCE & LESS WEIGHT



YOSHIMURA SLIP-ON EXHAUST

EXPERT CHOICE

- Made from 304-grade stainless steel.
- Better sounding, better looking and lighter than stock muffler.

- USDF/USDA approved spark arrester.
- NON EPA compliant (for racing application only).
- Not EC compliant.

- Fuel injection system tuning not required.
- Not compatible with CARB & T Category models 2018 and up.

OUTLANDER

G2 2018 & prior (except 6x6 models)
715001738

G2 2019 & up (except 6x6 models)
715005480

RENEGADE

G2S 2018 & prior (except 570 engine and X mr models)
715001739

G2S 2019 & up (except 570 engine and X mr models)
715005481



OUTLANDER | RENEGADE



FOAM AIR FILTER BY TWINAIR†

- Maximizes performance by increasing air flow throughout RPM range.
- Maintenance-friendly, i.e. just wash, re-oil and re-use after riding in severely dusty/muddy environments.

G2, G2S, G2L
715001333



HEAVY-DUTY SPRINGS

- Heavy-duty springs provide enhanced stiffness.
- Perfect for snow clearing and hauling heavy loads.
- Improves handling and helps prevent accidental overturns.
- Sold in pairs.

Front
G2 2012-2018 (Base model, DPS, XT, X mr with 650 engine only & Limited) G2S (Base model with 500 & 570 engines only)
• Standard on Outlander Pro and Mossy Oak models.

715003199

Rear
G2 2012-2018 (Base model, DPS, XT & X mr with 650 engine only) G2S (Base model with 500 & 570 engines only)
• Standard on Outlander Pro and Mossy Oak models.

715003200

NEW G2L
(Except Mossy Oak, PRO and X mr models)
715007203



Front



Rear

Front & Rear
G2 2019 (Base, DPS & XT models)
• Standard on Outlander Pro and Mossy Oak models.

715005159



FOX SHOCKS

- Engineered for the more aggressive riders.
- Offer increased bump absorption and better roll control.
- Offer a slightly firmer ride than standard kits but remain very versatile for all-around use.
- Kit includes 4 shocks and springs.
- Rebuildable.
- Threaded preload adjusters.

G2 2012-2018 (except X mr, XT-P, Limited & 6x6 models), G2 X mr 650 (2012-2018), G2S (Base model with 500 & 570 only), G2L & G2L MAX
715001471

G2, G2S 2019 & up
715005469



FOX PERFORMANCE SHOCKS 1.5 PODIUM X RC2 HPG

- High-performance front and rear shocks.
- Allow handling to readily adapt to terrain and riding style.
- Easy-adjust dual-speed compression, rebound and preload settings.
- Standard on G2S X xc.

G2 2012-2018 (except X mr, Limited & 6x6) G2 X mr 650 & G2S (Base model & X mr 570 only)
715003201

G2 2019 & up
715005470

FRONT SHOCK COVERS

- Feature ventilation holes.
- Offer added protection in rough terrain and weather conditions.
- Sold in pairs.

G2, G2L, G2S
715500301



EMERGENCY KIT

- Complete emergency kit provides all essential equipment and supplies to get out of most unfavorable situations powersport enthusiasts may find themselves in.
- Includes jumper cables, air compressor, tire-repair kit, first-aid kit, ratchet tie-down, duct tape, 3,300 lb (1,500 kg) tow strap, zip-ties and cloth rags.

715006102



OUTLANDER | RENEGADE

TRAILERING COVERS

- Heavy-duty canvas made of UV-resistant solution-dyed polyester.
- Protect windshield and colored panels from abrasion.
- All high-abrasion areas are reinforced with a double canvas layer.
- Opening for fuel cap access.
- Weather-resistant trailering cover protects your vehicle during transportation.
- Quick and easy installation.
- Designed to perfectly fit your vehicle with or without Can-Am accessories.

G2 (except MAX models) 715001737	G2L (except MAX models) 715002026	G2S (except X mr models) 715000683
G2 (MAX models only) 715001736	G2L (MAX models only) 715002025	G2 (6x6 models only) 715004488



FLAG

- Make sure everyone knows what you're riding.
 - Perfect for the dunes and new riders.
 - 8-ft. (2.4 m) length.
 - Includes flag mount (715000127).
- 715000277 · Yellow

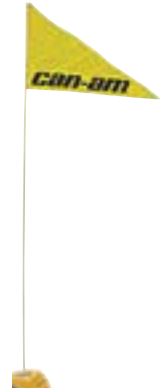

STORAGE COVERS

- Weather-resistant storage covers.
- For vehicle storage only.
- UV-resistant solution-dyed polyester construction.
- Quick and easy installation.
- Designed to perfectly fit your vehicle with or without Can-Am accessories.

G2, G2L, G2 X mr (except 1000), G2L X mr, G2S, G2S X mr 715001720	G2 (6x6 models only) 715002492	G2 MAX, G2 X mr 1000, G2L MAX 715001735 · Mossy Oak Break-Up Country Camo
G2, G2L (MAX models only) 715001668	G2, G2L (except MAX models) 715001597 · Mossy Oak Break-Up Country Camo	



FLAG MOUNT

715000127

BOLT-ON[®] RETRACTABLE RATCHETING TIE-DOWNS

- Perfect for transporting your powersport vehicle or securing loads.
 - Mounts easily: Bolts on any flat surface (e.g. truck bed or frame).
 - 1" x 6" (2.5 cm x 1.8 m) tie-down strap with heavy-duty stitching that delivers a 500 lb (226 kg) working load strength and 1,500 lb (680 kg) break strength.
 - Convenient retractable push button automatically slackens, spools and stores away strap, while the ratchet mechanism tightens the strap snugly to secure your vehicle or load into place.
 - Rubber ratcheting handle provides firm grip, and the hook is vinyl coated to protect whatever surface it hooks into.
 - Sold in pairs.
- 295100737



RATCHET TIE-DOWNS

- 400 lb (181 kg) safe working load.
 - 1" x 10' (2.5 cm x 3 m) strap with Can-Am, Sea-Doo, and Ski-Doo logos.
 - Deluxe ratchet with rubber handle.
 - Coated S hooks.
 - Pack of 2.
- 860200447 · Black/Grey



NEW HEAVY-DUTY RATCHET TIE-DOWN

- 1,000 lb (454 kg) safe working load.
 - 1.5" x 6' (38 mm x 1.8 m) strap with BRP brands.
 - Deluxe ratchet with rubber handle.
 - Black-coated clip hooks.
 - 12" (300 mm) webbing included.
 - Pack of two.
- 715006227



NEW SHIFTER LOCK

- Secure the vehicle's shifter by locking it in position.
- Prevents the vehicle from going into neutral without the lock key.

G2, G2L
715007337



LOCKABLE GAS TANK CAP

- Protects your fuel.
- Meets EPA requirements.

G2, G2L, G2S
860200387



LICENSE PLATE BRACKET

- Provides specific area to install license plate.
- Mounts to rear of vehicle.

G2L 715002498 **G2S** 715001401



DECAL

- 6" x 12 3/4" (15 cm x 32 cm).
- 704901483



APACHE

TRACK SYSTEMS



EACH TRACK HAS A SPECIFIC PURPOSE AND IS DESIGNED WITHOUT COMPROMISE FOR WORK AND PLAY. WHETHER IT'S FOR DEEP SNOW RIDING, TRAIL RIDING OR HEAVY LOADS, APACHE TRACKS ARE AKIN TO FLOATING ACROSS THE TERRAIN.

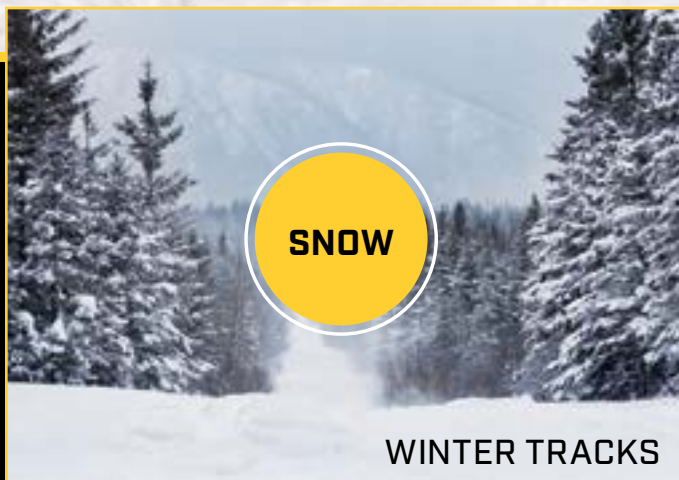

WINTER TRACKS

APACHE BACKCOUNTRY

Finally explore winter with no traction limitations and no compromise, thanks to the unmatched performance of Apache Backcountry track kits. Engineered to thrive in the deepest snow—for work or play. Don't let winter stand in the way.



YEAR-ROUND TRACKS

APACHE 360, 360 LT

These track kits improve your vehicle's ground clearance and increase its contact patch with the terrain. Adapt your track setup to the conditions you'll be riding in and the purpose of your ride, with the Apache 360 and 360 LT systems: as our all-season, all-terrain masterpieces.

WINTER TRACKS

GET THE MOST OUT OF YOUR CAN-AM ATV THIS WINTER FOR ALL YOUR ENDEAVORS.

Explore without compromise. Ride on untouched trails, traveling deep into winter's embrace, and you'll know: the same technology behind our world-renowned snowmobiles is at your command. With a larger contact patch, and more aggressive track design, travel beyond what you thought possible with the best snow performance.



COVERED BY A
1-YEAR WARRANTY

OUTLANDER | RENEGADE | **APACHE BACKCOUNTRY**

Efficient frame and rail design ensures weight is evenly distributed on snow

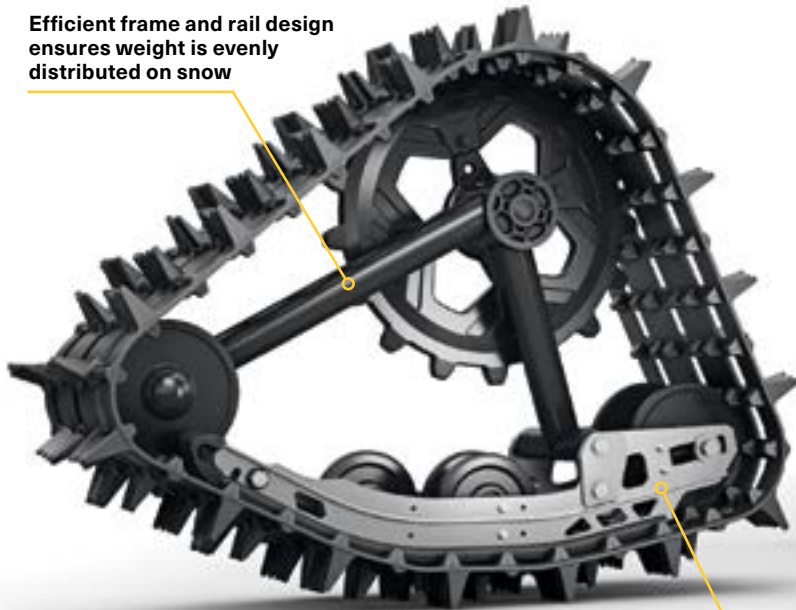

Largest contact patch anywhere: 23% more than the Apache 360 LT

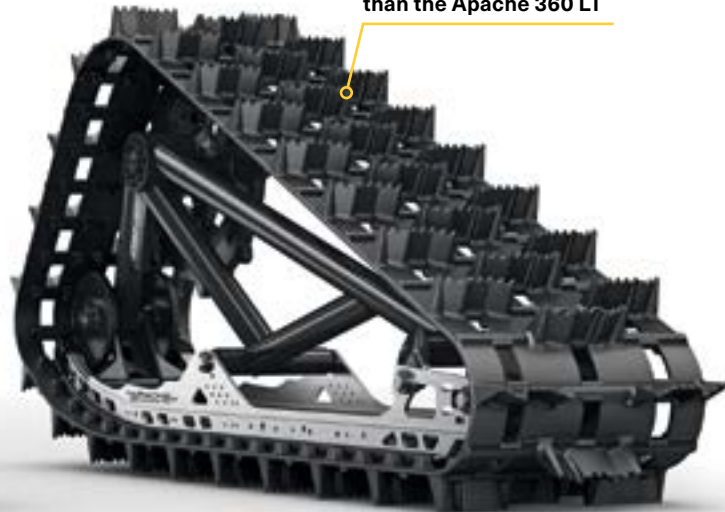

Easy-to-operate snowmobile-type sliding tensioner

APACHE BACKCOUNTRY TRACK SYSTEM

- Designed to deliver the best flotation level and deep-snow performance on the market.
- Contact patch is 23% bigger than the Apache 360 LT.
- Impressive added ground clearance of 7" (18 cm), keeps the vehicle out of deep snow.
- Aggressive track design with 2" (5 cm) lug height for maximum traction on snow.
- Apache Backcountry Mounting Kit and engine and CVT air intake pre-filters are required.
- For winter use only.

G2 (except 6x6 models), G2S, G2L
715003042

IDLER WHEEL KIT

- Reduces drag and rolling resistance.
- Includes 2 wheels, brackets and hardware.
- Add up to 2 kits per rear track.
- Can extend slider life in hardened snow conditions.

Apache Backcountry Track System (rear tracks only)
860201230 - 141 mm



SLIDERS WITH VESPEL⁺ INSERTS

- Use DuPont Vespel inserts for less friction.
- Longer life.
- Can be cut to desired length.
- 8 needed per vehicle.
- Sold individually.

Apache Backcountry Track System
503194815



RAIL ICE SCRATCHERS

- Provide additional lubrication in hard and icy conditions.
- Rail mounted, small, light.
- Design expands on coil concept to allow reversing without damage.
- Easily stored when not in use.

Apache Backcountry Track System
860201728



YEAR ROUND TRACKS

WORK & PLAY YEAR ROUND THROUGH MUD, SNOW, & ALL TYPES OF TERRAIN.

Rise above terrain, weather, and whole seasons with the Apache 360, 360 LT and 360 LT 6x6 track kits, the upgrade that takes the Can-Am experience to another level. Designed for superior traction and carrying heavier loads in soft terrain, they can be used with your ATV year round for exploring and completing tough tasks.

COVERED BY A
**2-YEAR
WARRANTY**



OUTLANDER | RENEGADE | APACHE 360 & 360 LT

Added ground clearance of 4.5" (11.4 cm)

APACHE 360

APACHE 360 LT

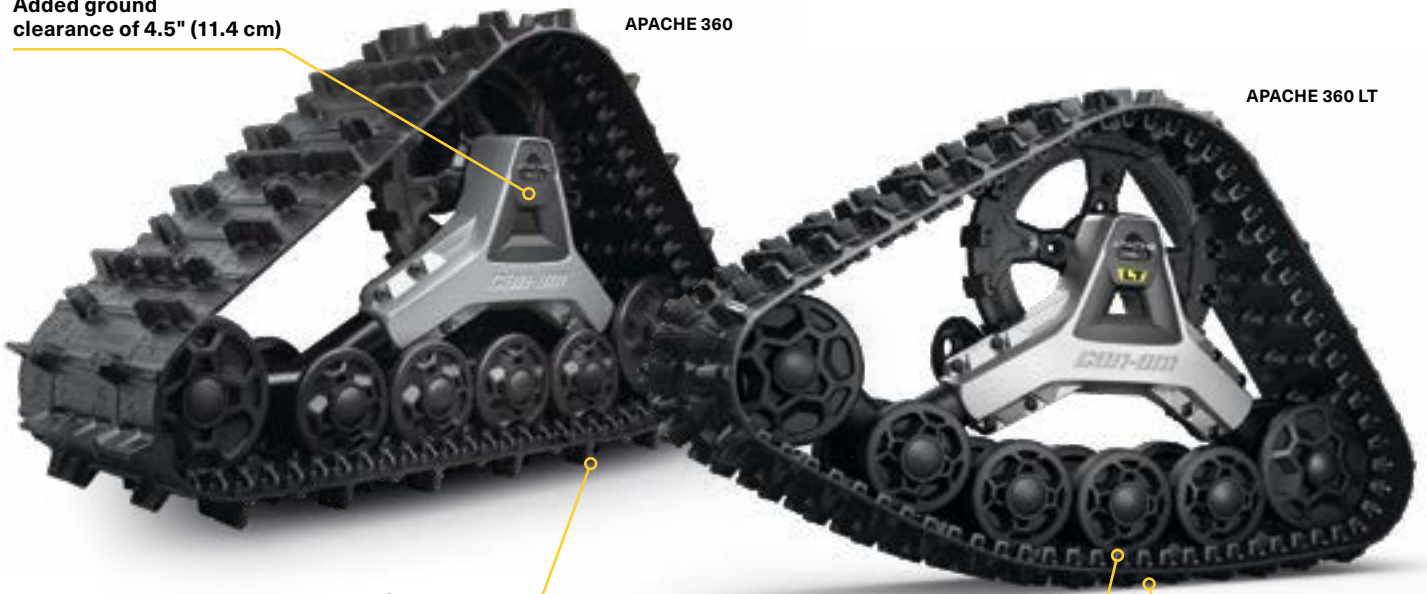

Total ground surface area: 2,079.7 in² (13,417 cm²)

Unique adjustable contact patch system to tackle the toughest year-round conditions

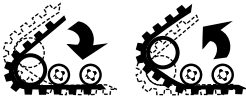

Rubber over molded heavy-duty double bearing wheels and offset wheel spacing reduce friction and vibration while ensuring reliability

Ground surface area is 7 to 9% larger than the Apache 360's

APACHE 360 TRACK SYSTEM

- Multifunctional tracks perfect for any Can-Am ATV.
- Average ground clearance of 16" (41 cm).
- 1" (2.5 cm) lugs in the front and 1.25" (3.2 cm) in the back.
- Apache 360 & 360 LT Mounting Kit and engine and CVT air intake pre-filters are required.

G2 (except 6x6 models), G2L, G2S
715006323

APACHE 360 LT TRACK SYSTEM

- Multifunctional tracks designed to support heavy loads and to fit on most Can-Am Off-Road vehicles.
- Front wheel height adjustment provides enhanced attack angle and better performance over rough terrain when raised or increased contact patch for improved flotation when lowered.
- Average ground clearance increase of 4.5" (11.4 cm).
- 1" (2.5 cm) lugs in the front and 1.25" (3.2 cm) in the back.

G2, G2S, G2L
715005103

- Reliable heavy-duty build.
- EC compliant.
- Contact patch is 7 to 9% bigger than the Apache 360's.
- Apache 360 and 360 LT Mounting Kit, Track DPS Module and engine and CVT air intake pre-filters are required.



OUTLANDER 6x6 | APACHE 360 LT 6x6

Added ground clearance of 4.5" (11.4 cm)



Unique adjustable contact patch system to tackle the toughest year-round conditions



Rubber over molded heavy-duty double bearing wheels and offset wheel spacing reduce friction and vibration while ensuring reliability

APACHE 360 LT (6x6) TRACK SYSTEM

- Multifunctional tracks designed to support heavy loads and to fit on most Can-Am Off-Road vehicles.
- Front wheel height adjustment provides enhanced attack angle and better performance over rough terrain when raised or increased contact patch for improved flotation when lowered.
- Average ground clearance increase of 4.5" (11.4 cm).
- 1" (2.5 cm) lugs in the front and 1.25" (3.2 cm) in the back.
- Apache 360 LT Mounting Kit, Track DPS Module and Engine & CVT Pre-Filter Kit are required.
- Reliable heavy-duty build.
- EC compliant.
- Exclusively for the Outlander 6x6.
- Recommended for use on snow only.

G2, G2L (6x6 only)
715005104

ATV TRACK SYSTEM FITTING GUIDE

Track Kit	Vehicle	Mounting Kit	DPS Module (2020 and prior)	Pre-Filter
APACHE BACKCOUNTRY 715003042	G2, G2S 2018 & prior & G2L	715004830	715007338	Air Intake Pre-Filter 715004729 + CVT Air Intake Pre-Filter 715003483 <i>Standard on G2 models and G2L PRO model</i>
	G2, G2S 2019 & up	715004796		
APACHE 360 715006323	G2, G2S 2018 & prior & G2L	715007207	715007338	
	G2, G2S 2019 & up	715007206		
APACHE 360 LT 715005103	G2, G2S 2018 & prior & G2L	715007207	715007338	
	G2, G2S 2019 & up	715007206		
APACHE 360 LT 6x6 715005104	G2 2018 & prior, G2L (6x6 models)	715004991	715007338	
	G2 6x6 models 2019 & up	715005105		

APACHE BACKCOUNTRY MOUNTING KIT

- (Not illustrated)
- Required for installation of the Apache Backcountry Track System.
 - DPS module and pre-filter are required and sold separately.

G2 2018 & prior, G2S 2018 & prior, G2L
715004830

G2 2019, G2S 2019
715004796

TRACK DPS MODULE

- (Not illustrated)
- An innovative DPS module that ensures speedometer accuracy and optimized steering assist, which make for perfect track control and riding ease.
 - Required to install the and Backcountry Track Systems.

Models without Intelligent Throttle Control (ITC™) (2020 and prior)
715005243

G2, G2L, G2S (Models with Intelligent Throttle Control ITC™)
715007338

CVT AIR INTAKE PRE-FILTER

- Adds extra protection to your engine in harsh riding conditions.
- Filter blocks particles larger than 0.007" (0.19 mm).
- Easy, tool-less installation.
- Necessary to maintain vehicle warranty when tracks are installed.
- Required to install the Apache and Backcountry Track Systems.
- Standard on Outlander 650, 650 X mr, 850, 1000, 1000R engines and G2L PRO.

715003483



APACHE 360 & 360 LT MOUNTING KIT

- (Not illustrated)
- Required to install Apache 360 & 360 LT Track Systems.
 - DPS module and pre-filter not included.

G2 2018 & prior (except 6x6 models), G2S 2018 & prior, G2L
715007207

G2 2018 & prior, G2L (6x6 models)
715004991

G2 2019 & up (except 6x6 models), G2S 2019 & up
715007206

G2 (6x6 models 2019 & up)
715005105

ENGINE AIR INTAKE PRE-FILTER

- Adds extra protection to your engine in harsh riding conditions.
- Filter blocks particles larger than 0.005" (0.13 mm).
- Necessary to maintain vehicle warranty when tracks are installed.

G2, G2L, G2S
715004729



EXPERT CHOICE

SELF-CLEARING FOOTWELLS

- Made from aluminum.
- Replace original footwells.
- Feature large evacuation ports to avoid mud and snow accumulation in footwells.
- Aggressive design for improved traction.
- Not compatible with Body Side Protectors.
- Sold in pairs.

G2 2015 & up, G2L
715004759



PROMOUNT PLOWS

THE PROMOUNT LINEUP WAS CREATED FOR BOTH PROFESSIONAL OPERATORS AND ENTHUSIASTS LOOKING TO TAKE THEIR TOOL KIT TO THE NEXT LEVEL. DESIGNED TO WORK AS EFFICIENTLY AS POSSIBLE, CAN-AM REIMAGINED THE PLOW FROM MOUNT TO BLADE.

PROMOUNT
— PLOWS

MOST EFFICIENT MOUNTING SYSTEM

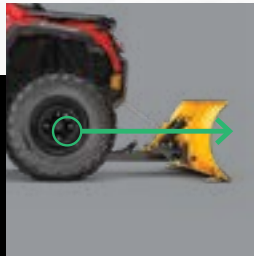

Underbelly mounting plate provides the **optimal angle of attack** for best push strength.

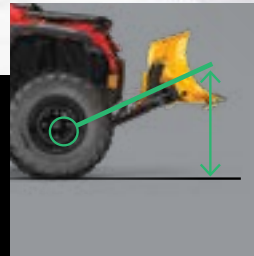

The forward mounted push frame provides **industry leading lift height**.



Low profile mounting plate has **little impact on ground clearance** and can be left installed year round.

CONNECTS WITH A CLICK

Attachable in **FOUR EASY STEPS**, the Can-Am ProMount plow system is the fastest, easiest way to start plowing and get the job done—minimal effort for maximum result.

1

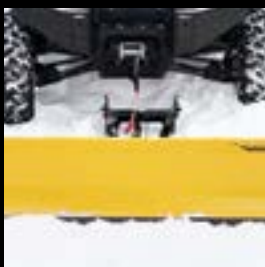

Drive straight toward the plow.

2



Attach the winch cable to the plow using a guiding hook/roller.

3



Lift the plow until it clips onto the mounting plate.

4



Remove the winch cable from the guide. You're ready to plow.

STEEL PLOWS

OUTLANDER | RENEGADE | CAN-AM PROMOUNT STEEL PLOW KITS

These kits include:

- Can-Am ProMount Steel Blade
- Push Frame with Quick-Attach System
- Mounting Plate

54" [137 CM] BLADE

- G2, G2L, G2S
- 715005200 · Black
 - 715005428 · Yellow

60" [152 CM] BLADE

- G2, G2L, G2S
- 715005201 · Black
 - 715005434 · Yellow

66" [168 CM] BLADE

- G2, G2L, G2S
- 715005427 · Black
 - 715005435 · Yellow

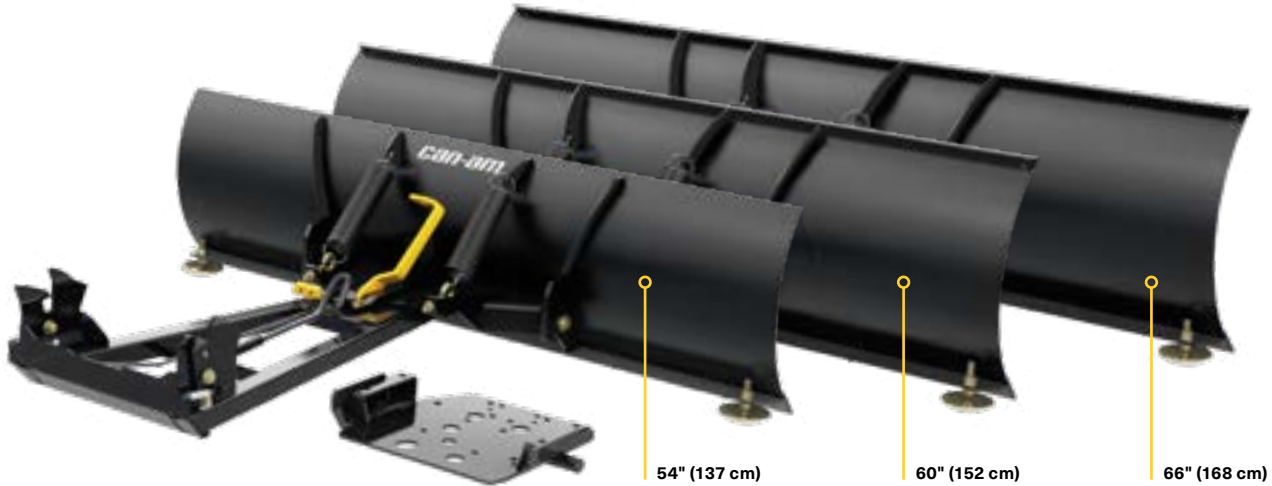

OUTLANDER | RENEGADE | CAN-AM PROMOUNT STEEL BLADES

- Blades available individually to create your own kit.
- Compatible with Can-Am ProMount Blade accessories to further enhance plow versatility (some plow accessories are not compatible with 54" (137 cm) plows).

54" [137 CM] BLADE

- Not compatible with ProMount Drift Cutters, Blade Extensions and Edge Markers.
- Clears 50" (127 cm) when plow is fully angled.
- Blade height of 14.75" (37 cm).

Fits ProMount Push Frame

- 715004472 · Black
- 715005316 · Yellow

60" [152 CM] BLADE

- Clears 54" (137 cm) when plow is fully angled.
- Blade height of 17" (43 cm).

Fits ProMount Push Frame

- 715004202 · Black
- 715005317 · Yellow

66" [168 CM] BLADE

- Clears 60" (152 cm) when plow is fully angled.
- Blade height of 17" (43 cm).

Fits ProMount Push Frame

- 715006337 · Black
- 715005318 · Yellow

72" [183 CM] BLADE

- Clears 66" (168 cm) when plow is fully angled.
- Blade height of 17" (43 cm).

Fits ProMount Push Frame

- 715004474 · Black
- 715006021 · Yellow



CONSULT YOUR DEALER FOR THE BEST PLOW WIDTH. Made from 12-gauge steel and designed for efficient plowing, the ProMount steel blades are offered in multiple sizes to fit jobs large or small.

CREATE YOUR OWN KIT

by choosing any plow type/length that you'd like for your push frame. **ProMount Push Frames are compatible with all the blades.**

WHEN IT COMES TO SNOW,
THE WAY TO GO IS CLEAR.



ANGLE PLOWS

NEW | OUTLANDER | RENEGADE | CAN-AM PROMOUNT ANGLE BLADES

- Make the job easier with the right tools, clear long alleys and make the task easier by sending the snow further out of the way.
- Wing end of plow measures 25" (645 cm) high and tapers down to 17" (43 cm).
- One-way "winged" state plow designed to throw snow higher.
- Rubber flap designed to keep snow away from the driver.
- Can-Am branded.

**60" [152 CM]
STEEL ONEWAY
STATE BLADE**

■ 715007261 · Black

**66" [168 CM]
STEEL ONEWAY
STATE BLADE**

■ 715007263 · Black

**72" [183 CM]
STEEL ONEWAY
STATE BLADE**

■ 715007264 · Black



60" (152 cm)

66" (168 cm)

72" (183 cm)

PROMOUNT ONE-WAY STATE BLADE RUBBER FLAP

(Not illustrated)

- Allows for more efficient snow projections in various snow conditions.

715007299

CREATE YOUR OWN KIT

by choosing any plow type/length that you'd like for your push frame. **ProMont Push Frames are compatible with all the blades.**

HMWPE (High Molecular Weight Polyethylene) technology gives Flex2 greater reliability, resistance to impact, and immunity to rust or deformation. Tough on jobs but flexible in the face of obstacles, the Flex2 blade simplifies work.

FLEX2 PLOWS

OUTLANDER | RENEGADE | CAN-AM PROMOUNT FLEX2 PLOWS

These kits include:

- Can-Am ProMount Flex2 Blade
- Push Frame with Quick-Attach System
- Mounting Plate

60" [152 CM] BLADE

G2, G2L, G2S

■ 715005202 · Black



OUTLANDER | RENEGADE | CAN-AM PROMOUNT FLEX2 BLADES

- Plow blade made of UHMWPE, flexible and impact absorbing material prevents damaging your plow when accidental impacts occur.
- Replacable wear blade.
- Large pin designed for easy blade rotation to eliminate snow buildup at pivot point.
- Blade design provides best snow roll-off at any angle.
- Compatible with Can-Am ProMount Blade accessories to further enhance plow versatility.

60" [152 CM] BLADE

- Clears 54" (137 cm) when plow is fully angled.

Fits ProMount Push Frame

■ 715004203 · Black

72" [183 CM] BLADE

- Clears 66" (168 cm) when plow is fully angled.

Fits ProMount Push Frame

■ 715004485 · Black



HMWPE (High Molecular Weight Polyethylene) technology gives Flex2 greater reliability, resistance to impact, and immunity to rust or deformation. Tough on jobs but flexible in the face of obstacles, the Flex2 blade simplifies work.

CREATE YOUR OWN KIT

by choosing any plow type/length that you'd like for your push frame. **ProMount Push Frames are compatible with all the blades.**

YOUR JOB, YOUR CHOICE

Get a custom solution that truly fits the task at hand—with quality components and no cut corners. The ProMount push frame, mounting plate and blades are a universal system that can be adapted to your specific Can-Am and job site.



OUTLANDER | RENEGADE

CAN-AM PROMOUNT PUSH FRAME WITH QUICK-ATTACH SYSTEM

- Heavy-duty steel tubes designed to withstand the roughest use.
- Mid-mount carriage provides ultimate push strength and traction.
- Designed for maximum plow lift height.
- Features a self-aligning quick-attach system, an easy foot release pedal and an ergonomic handle for plow angle adjustment.

G2, G2L, G2S
715004339



COMPATIBLE WITH ALL PROMOUNT PLOWS

CAN-AM PROMOUNT MOUNTING PLATE

- Required to install the Can-Am ProMount Push Frame with Quick-Attach System.
- Mounting plate precision-designed to stay on year round without compromising ground clearance.
- Fits on ATVs, Maverick Trail or Maverick Sport with or without Can-Am Skid Plates.

G2, G2L, G2S
715004338



CAN-AM PROMOUNT PUSH FRAME EXTENSION

- 12" (30 cm) push frame extension.

G2, G2L, G2S
715006257

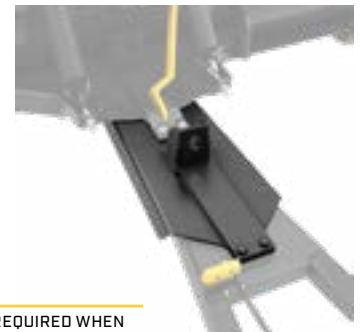

REQUIRED WHEN PLOW IS INSTALLED WITH APACHE TRACK SYSTEM



OUTLANDER | RENEGADE | CAN-AM PROMOUNT PLOW ACCESSORIES

CAN-AM PROMOUNT EDGE MARKERS

- Help locate the edges of your plow.
- Height: 24" (60 cm).
- Sold in pairs.
- Compatible with Can-Am ProMount Steel and Flex2 Blades with or without Blade Extensions (except for the Can-Am ProMount Steel 54" (137 cm) Blades).

G2, G2L, G2S
715004206

CAN-AM PROMOUNT DRIFT CUTTERS

- Help keep snow in the plow.
- Dimensions: 17" x 13" (43.2 cm x 33 cm).
- Sold in pairs.
- Compatible with Can-Am ProMount Steel and Flex2 Blades with or without Blade Extensions (except for the Can-Am ProMount Steel 54" (137 cm) Blades).

G2, G2L, G2S
715004207

CAN-AM PROMOUNT PLASTIC WEAR BLADE

- To help prevent scratches on smooth driveways and markable surfaces.

G2, G2L, G2S

54" (137 cm)
715004480

66" (168 cm)
715004482

60" (152 cm)
715004481

72" (183 cm)
715004483

CAN-AM PROMOUNT BLADE EXTENSIONS

- Add 3" (8 cm) each side.
- Compatible with Can-Am ProMount Blades (except for Can-Am ProMount Steel 54" (137 cm) Blade).
- Longer Wear Blade can be installed to further extend the extra length already provided by the extensions.
- Compatible with Can-Am ProMount Steel and Flex2 Blades (except for the Can-Am ProMount Steel 54" (137 cm) Blades).

G2, G2L, G2S

■ 715004205 - Black
■ 715005319 - Yellow



PLOW ROLLER FAIRLEAD

- Larger diameter lower roller reduces wear on wire rope for plow application.
- Can be used with all ProMount plows.

G2, G2L, G2S

715001223



SYNTHETIC WINCH CABLE FOR PLOWING

- Specially designed for plowing applications.
- 8' (2.4 m) section of durable, extra-strong synthetic rope.
- Stands up to repeated, sharp angle pulls used to lift heavy plow blades.
- Temporarily replace your winch rope for plow season to save wear and tear on wire rope.

715000540



PULLEY KIT

- Pulley kit to be used in conjunction with the winch when using a snow plow.
- Recommended to increase winch efficiency.
- To be used with the XT Front Bumper.

715000279



PLOW LIMIT SWITCH

(Not illustrated)

- For controlling the cable tension when over raising your plow system.
- Prevents winch, plow push frame and vehicle damage.

G2, G2L, G2S

715004775



TIRES

CARLISLE ACT TIRE

G2 (500-1000 XT models only)

Front - 26" x 8" x 12"

705401333

705401334 · 

Rear - 26" x 10" x 12"

705501769

705501770 · 

G2 (400 XT models only)

Front - 25" x 8" x 12"

705400606

705400326 · 

Rear - 25" x 11" x 12"

705500933

705500598 · 

CARLISLE ACT HD TIRE

Front - 26" x 8" x 12"

705402562

Rear - 26" x 10" x 12"

705502940



CARLISLE BADLANDS A/R TIRE

G2 (500-1000 Base models only)

Front - 26" x 8" x 12"

705401331

705401332 · 

Rear - 26" x 10" x 12"

705501767

705501768 · 



CARLISLE TRAIL WOLF TIRE

G2 (400 Base models only)

G2L (450/570)

Front - 25" x 8" x 12"

705402433

705400607 · 

Rear - 25" x 11" x 12"

705502856

705502165 · 



*Consult your operator's guide/owner's manual for proper tire type and rim sizing. Improper tire type and rim selection may affect vehicle handling. Check with your local authorities for proper regulation.

ITP TERRACROSS TIRE

- This smooth-riding tire will command every bit of traction from the ground while still managing to float across loose snow, sand and mud.
- Features extreme-duty construction for improved puncture protection and extra-tough rubber compound for increased tread life. The interlocking tread pattern and wide footprint make it one of the toughest and grippiest radials around.
- Not EC compliant.

G2 XTP, G2 Limited
 Front - 26" x 8" x 14"
705402435

Rear - 26" x 10" x 14"
705502858



ITP HOLESHOT ATR TIRE

G2S
 Front - 205/80R12
 25" x 8" x 12"

705400600
705400475 ·

Rear - 270/60R12
 25" x 10" x 12"

705500926
705500820 ·



ITP MEGA MAYHEM

- 1.5" tread depth mud thrower tires.
- Surprisingly smooth ride on hard pack surfaces.
- 6-ply rated.

G2 X mr 570 & 650 2018 & up
G2S X mr 570 2018 & up
 Front 28" x 9" x 12"
705402131

Rear - 28" x 11" x 12"
705502645



ITP CRYPTID TIRE

- Graduated lug height and paddle-like shoulder configuration provide maximum side bite for climbing in and out of the mud without compromising ride comfort on trails and hard pack.
- 6-ply rated.
- 30" x 9" x 14".

G2 X mr 850 & 1000R 2018 & up
G2S X mr 1000R 2018 & up
705402671



GORILLA SILVERBACK TIRE

- AT30X9-14 Gorilla Silverback mud tire.
- Sold individually.
- Not EC compliant.

G2 (850 & 1000 models only)
 30" x 9" x 14"
705400962



MAXXIS MUDZILLA TIRE

- Not EC compliant.
- G2 (X mr 570 & 650 models only)**
 Front - 28" x 8" x 12"

705401391

Rear - 28" x 10" x 12"
705501836



KENDA KLAW MXR TIRE

DS 90 X
 Front - 20" x 6" x 10"
V42711DGF01HLL

Rear - 18" x 10.5" x 8"
V42712DGF01HLL



*Consult your operator's guide/owner's manual for proper tire type and rim sizing. Improper tire type and rim selection may affect vehicle handling. Check with your local authorities for proper regulation.

RIMS

14" RIM

- Premium cast aluminum black painted with machining and clear coat rim.
- Center hole: 72 mm.
- Bolt circle pattern: 4/136 mm.

G2 DPS, G2 XT, G2 MAX 650, G2 MAX XT, G2 MAX Limited

Front - 14" x 6.5" offset = 40 mm

- 705401853 - Black and machined
- 705401852 - Black with clear coat
- 705401851 - Silver with clear coat

Rear - 14" x 8.5" offset = 50 mm

- 705502402 - Black and machined
- 705502401 - Black with clear coat
- 705502400 - Silver with clear coat



Note: Matching Nuts - 250100100 Black, 250100082 Chrome/Matching Cap - 705400928

14" RIM

G2 DPS, G2 XT, G2 MAX Limited, G2 North Edition, G2 MAX North Edition

Front - 14" x 6.5" offset = 40 mm

- 705402309 - Black and machined
- 705402222 - Black with clear coat
- 705402307 - Silver with clear coat

Rear - 14" x 8.5" offset = 50 mm

- 705502770 - Black and machined
- 705502702 - Black with clear coat
- 705502768 - Silver with clear coat



OUTLANDER X MR AND DEFENDER RIM

- Cast aluminum rim with trend setting explosive styling so you can ride—and look—like a trailblazer.

X mr models front and rear wheels

Front - 14" x 6.5" offset = 10 mm

- 705401848 - Black and machined
- 705401849 - Black



Note: Matching Nuts - 250100100 Black, 250100082 Chrome/Matching Cap - 705401541

OUTLANDER RIM (CAMO MODEL)

- Black with clear coat aluminum rim.

G2, G2L, G2S

Front - 12" x 6" offset = 41 mm

- 705401127 - Black with clear coat

Rear - 12" x 7.5" offset = 51 mm

- 705501493 - Black with clear coat



12" BEADLOCK RIM

- Black with clear coat aluminum rim.
- Needs 16 bolts (250000787) for installing the beadlock.
- Choice of beadlock color (not included).

G2, G2L, G2S

Front - 12" x 6" offset = 41 mm

- 705401678 - Black

Rear - 12" x 7.5" offset = 51 mm

- 705502244 - Black

14" BEADLOCK RIM

- Black with clear coat aluminum rim.
- Choice of beadlock color (not included).
- Needs 16 bolts (250000787) for installing the beadlock.

G2

Front - 14" x 6.5" offset = 41 mm

- 705401594

Rear - 14" x 8" offset = 51 mm

- 705502146

12" BEADLOCK RING

- Cast aluminum beadlock.
- Must be installed on Front Rim (705401678) and Rear Rim (705502244).

G2, G2L, G2S

- 705401763 - Can-Am Red
- 705401810 - Yellow
- 705401811 - Orange Crush
- 705401812 - Manta Green



Note: Matching Nuts - 250100184 Black, 250100185 Chrome/Matching Cap - 705400928

14" BEADLOCK RING

- Cast aluminum beadlock.
- Must be installed on Front Rim (705401594) and Rear Rim (705502146).

G2

- 705401586 - Manta Green
- 705401702 - Octane Blue
- 705401837 - Can-Am Red
- 705401840 - Black



Note: Matching Nuts - 250100184 Black, 250100185 Chrome/Matching Cap - 705400928

*Consult your operator's guide/owner's manual for proper tire type and rim sizing. Improper tire type and rim selection may affect vehicle handling. Check with your local authorities for proper regulation.

APPAREL

Clothing, helmets, glasses and everything else you need to shift your Can-Am experience into high gear.



PARTS & MAINTENANCE

Essential items to keep your Can-Am tearing up the tarmac, including oils, filters maintenance products and cleaning products.



EXPLORE AN ENTIRE WORLD OF ADVENTURE WITH ALL OF OUR BRP PRODUCTS. BRP.COM



ski-doo *LYNX* *SEA-DOO* *CAN-AM* *ROTAX* *ALUMAcraft* *Manitou* *EVINRUDE*



CAN-AMOFFROAD.COM

